

Next Generation Tools By



TCT
BAND SAW
BLADE

New Edge of Technology
DIAMOND
TECHNOLOGY

Awe-inspiring
Precision &
Performance

BRAZE - REPLACEABLE - PCD
Wood Working Tools

The Sign Of Excellence

Next Generation Tools By



The Company, Yash Tooling System is setting new Benchmarks in tools' designing, manufacturing and overall quality operations. With introduction of these tools with Replaceable Knives, Yash now has the distinction of being the first Indian company to undertake manufacturing of such international quality products. In the late nineties, Brazed tools market was teeming with various manufacturers, yash though being late entrant – acquired a position of premium brand very quickly. Still the quality brazed tools users always prefer Yash over any other product. Yash uses the best European machinery & processes to manufacture its products, with highest quality raw material. In short, Brazed or Replaceable, Yash tools are powered to give unbeatable performance and a long – long working life.

To win the markets, you have to do something extra – ordinary. Yash helps you achieve that. Your wood-work and panel jobs can be crafted so meticulously and consistently qualitatively that your product stand apart from the crowd, making you a winner of the customer choice. Yash Symbolises ultimate quality. Such highly dependable and systematically precision tools, till now were possible with imported brands only. Now you have it here in 'Yash', that too at comparably lower cost and with reliable supply and service support.

INNOVATIVE TOOLS FOR WOOD WORKING INDUSTRIES

Our In House Machine Facility

For

ENHANCE QUALITY | BETTER PERFORMANCE | UN BEATABLE PRICE
FASTEST DELIVERY | AFTER SALES & SERVICE



PCD Grinding



CNC Balancing Machine



Profile Grinding



CNC Profile Grinding



Induction Brazing



CNC Vertical Milling



CNC Turning



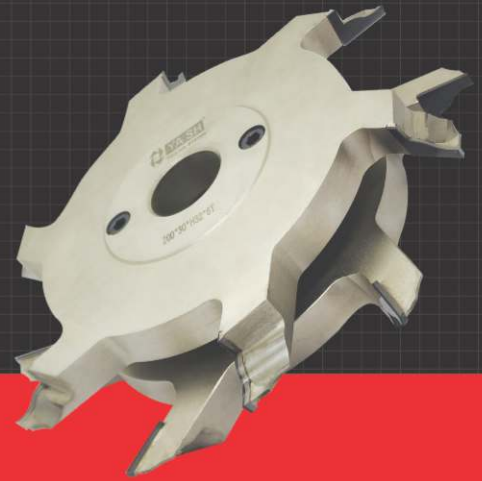
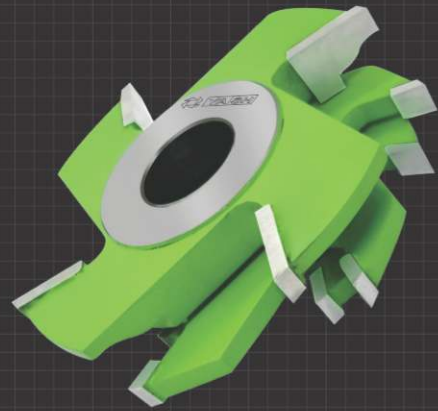

...discover It!

BRAZE - REPLACEABLE - PCD
Wood Working Tools

Braze Tooling

For : Door & Window, Kitchen Shutter, Solid Wood Finger Jointing Board, Grooving, Planning, Profiling For Furniture...

04



Replaceable Tooling

For : Door & Window, Kitchen Shutter, Solid Wood Finger Jointing Board, Grooving, Planning, Profiling For Furniture...

88



CNC Router

For : Grooving, Nesting, Engraving, Profiling & Planning...

Other Accessories

Hss Chain - Planner Blade - Collet - Holder - Diamond Wheel - Trimming Cutter

115



Saw Blades

For : Cutting...



157



PCD

For : Grooving, Cutting, Nesting, Profiling & Engraving...



168





BRAZE

Wood Working Tools

Grooving Cutter
BRAZE

05



Planning Cutter
BRAZE

08

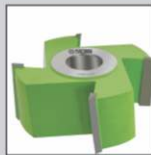

Counter Profile Counter
BRAZE

09



Raised Panel Cutter
BRAZE

18



Cutter Head Set for Door
BRAZE

22



Cutter Head-Set T&G
BRAZE

30



Glue Joint Cutter
BRAZE

44

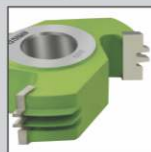

Finger Joint Cutter
BRAZE

49



Profile Cutter
BRAZE

50

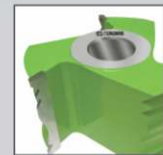

Cutter Head Set Railing Cutter
BRAZE

63

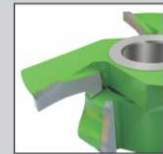

Handle Profile Cutter
Half Round Cutter
BRAZE

65

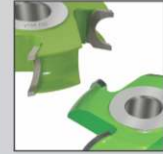

Wall Paneling

70



Wooden Leg Mfg.
Machines & Cutter

77

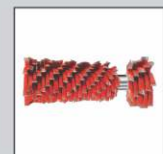

Tenoning Cutter &
UVPC

75



GROOVING CUTTER T.C.T (BRAZED) - YTB 1



Technical Drawing :

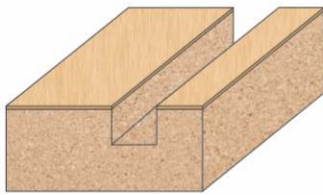
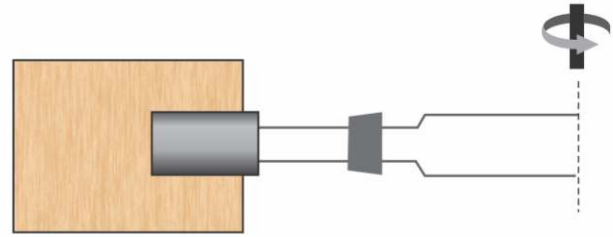

Technical Details :

Used On : Spindle Moulder Machines

Application :

Brazed Cutter For Good Grooving On Soft & Hard Wood And MDF. This Cutter Grooving & Rebating In Job From 4mm to 38 mm

YTB 1		DIA-100				
ORDER CODE	DIA	THICKNESS	BORE			TEETH
YTB 1 101	100	4	30	31.75	35	6
YTB 1 102	100	6	30	31.75	35	6
YTB 1 103	100	8	30	31.75	35	6
YTB 1 104	100	9	30	31.75	35	6
YTB 1 105	100	10	30	31.75	35	6
YTB 1 106	100	12	30	31.75	35	6
YTB 1 107	100	15	30	31.75	35	6
YTB 1 108	100	18	30	31.75	35	6
YTB 1 109	100	20	30	31.75	35	6
YTB 1 110	100	22	30	31.75	35	6
YTB 1 111	100	25	30	31.75	35	6
YTB 1 112	100	30	30	31.75	35	6
YTB 1 113	100	35	30	31.75	35	6
YTB 1 114	100	38	30	31.75	35	6

YTB 1		DIA-125				
ORDER CODE	DIA	THICKNESS	BORE			TEETH
YTB 1 115	125	4	30	31.75	35	6
YTB 1 116	125	6	30	31.75	35	6
YTB 1 117	125	8	30	31.75	35	6
YTB 1 118	125	9	30	31.75	35	6
YTB 1 119	125	10	30	31.75	35	6
YTB 1 120	125	12	30	31.75	35	6
YTB 1 121	125	15	30	31.75	35	6
YTB 1 122	125	18	30	31.75	35	6
YTB 1 123	125	20	30	31.75	35	6
YTB 1 124	125	22	30	31.75	35	6
YTB 1 125	125	25	30	31.75	35	6
YTB 1 126	125	30	30	31.75	35	6
YTB 1 127	125	35	30	31.75	35	6
YTB 1 128	125	38	30	31.75	35	6

YTB 1		DIA-150				
ORDER CODE	DIA	THICKNESS	BORE			TEETH
YTB 1 129	150	4	30	31.75	35	6
YTB 1 130	150	6	30	31.75	35	6
YTB 1 131	150	8	30	31.75	35	6
YTB 1 132	150	9	30	31.75	35	6
YTB 1 133	150	10	30	31.75	35	6
YTB 1 134	150	12	30	31.75	35	6
YTB 1 135	150	15	30	31.75	35	6
YTB 1 136	150	18	30	31.75	35	6
YTB 1 137	150	20	30	31.75	35	6
YTB 1 138	150	22	30	31.75	35	6
YTB 1 139	150	25	30	31.75	35	6
YTB 1 140	150	30	30	31.75	35	6
YTB 1 141	150	35	30	31.75	35	6
YTB 1 142	150	38	30	31.75	35	6

YTB 1		DIA-200				
ORDER CODE	DIA	THICKNESS	BORE			TEETH
YTB 1 143	200	4	30	31.75	35	8
YTB 1 144	200	6	30	31.75	35	8
YTB 1 145	200	8	30	31.75	35	8
YTB 1 146	200	9	30	31.75	35	8
YTB 1 147	200	10	30	31.75	35	8
YTB 1 148	200	12	30	31.75	35	8
YTB 1 149	200	15	30	31.75	35	8
YTB 1 150	200	18	30	31.75	35	8
YTB 1 151	200	20	30	31.75	35	8
YTB 1 152	200	22	30	31.75	35	8
YTB 1 153	200	25	30	31.75	35	8
YTB 1 154	200	30	30	31.75	35	8
YTB 1 155	200	35	30	31.75	35	8
YTB 1 156	200	38	30	31.75	35	8

Grooving Cutter For Spindel Moulder M/C T.C.T (Braze) - YTB 2

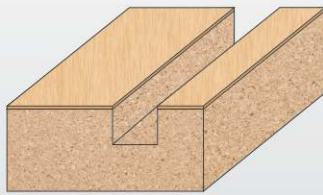

Technical Drawing :

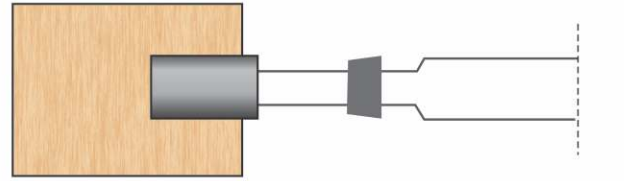

Technical Details :

Used On : Spindle Moulder Machines

Application :

Brazed Cutter For Good Grooving On Soft & Hard Wood And MDF Wood This Cutter Grooving & Rebating In Job Form 4mm to 18 mm

YTB 2		TEETH-12				
ORDER CODE	DIA	THICKNESS	BORE			TEETH
YTB 2 101	150	6	30	31.75	35	12
YTB 2 102	150	8	30	31.75	35	12
YTB 2 103	150	9	30	31.75	35	12
YTB 2 104	150	10	30	31.75	35	12
YTB 2 105	150	12	30	31.75	35	12
YTB 2 106	150	15	30	31.75	35	12
YTB 2 107	150	18	30	31.75	35	12

YTB 2		TEETH-16				
ORDER CODE	DIA	THICKNESS	BORE			TEETH
YTB 2 108	200	6	30	31.75	35	16
YTB 2 109	200	8	30	31.75	35	16
YTB 2 110	200	9	30	31.75	35	16
YTB 2 111	200	10	30	31.75	35	16
YTB 2 112	200	12	30	31.75	35	16
YTB 2 113	200	15	30	31.75	35	16
YTB 2 114	200	18	30	31.75	35	16

Grooving Cutter for Panel Saw Machine T.C.T (Braze) - YTB 3

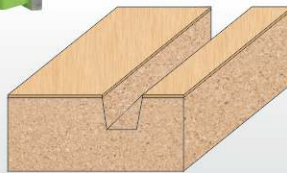

For Panel Saw

Technical Drawing :

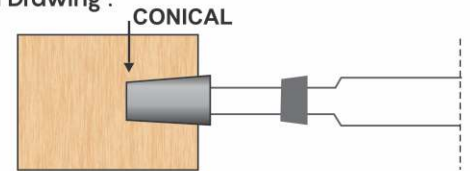

YTB 3		DIA	THICKNESS	BORE	TEETH
YTB 3 101	200	6.3	30	16	
YTB 3 102	200	7.3	30	16	
YTB 3 103	200	8.3	30	16	
YTB 3 104	200	9.3	30	16	
YTB 3 105	200	10.3	30	16	
YTB 3 106	200	11.3	30	16	
YTB 3 107	200	12.3	30	16	
YTB 3 108	200	6.3	30	24	
YTB 3 109	200	7.3	30	24	
YTB 3 110	200	8.3	30	24	
YTB 3 111	200	9.3	30	24	
YTB 3 112	200	10.3	30	24	
YTB 3 113	200	11.3	30	24	
YTB 3 114	200	12.3	30	24	

Technical Details :

Used On : Panel Saw Machines

Application :

These cutters are ideal tools for making precision slots and grooves. Perfect grooving in all materials, excellent finish without chipping marks But ideal on ply with laminated board and chip board.

Any Customized Specifications Also Can Make As Per Requirements

Grooving Cutter for Spindel Moulder Machine M/C T.C.T (Brazed) - YTB 4

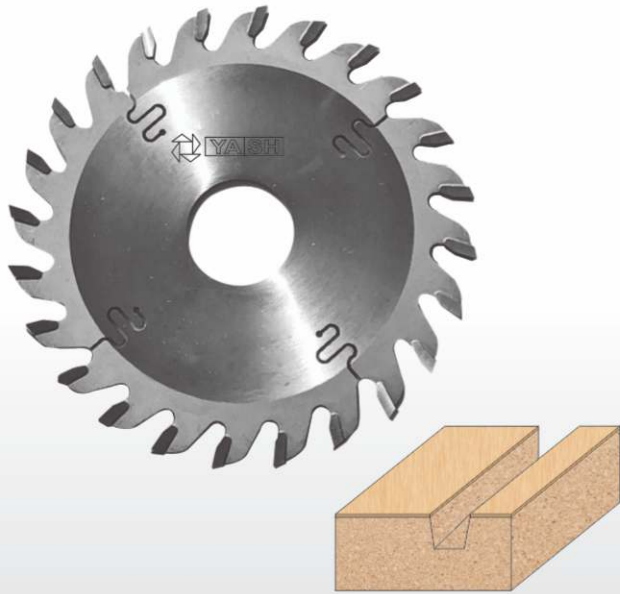

For Panel Saw

Technical Drawing :

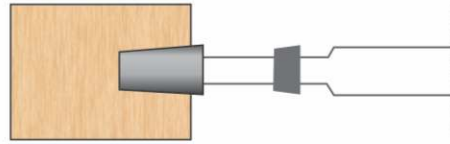

Technical Details :

Used On : Panel Saw Machines

Application :

These cutters are ideal tools for making precision slots and grooves. Perfect grooving in all materials, excellent finish without chipping marks But ideal on ply with laminated board and chip board.

YTB 4				
ORDER CODE	DIA	THICKNESS	BORE	TEETH
YTB 4 101	200	6.3	30	24
YTB 4 102	200	8.3	30	24
YTB 4 103	200	9.3	30	24
YTB 4 104	200	10.3	30	24
YTB 4 105	200	12.3	30	24

Adjustable Grooving Cutter T.C.T (Brazed) - YTB 5

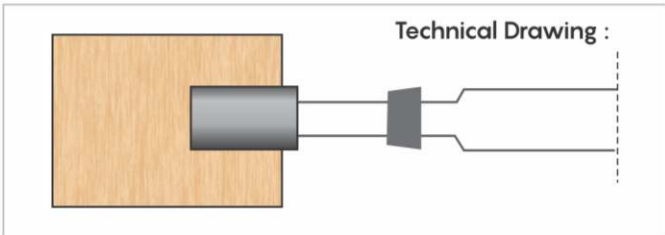

Technical Details :

Used On : Spindle Moulder & Four Side Moulder

Application :

Brazed Cutter for good Quality Adjustable Grooving on soft & hard Wood, These cutters are ideal tools for making precision slots and groves.

YTB 5					
ORDER CODE	DIA	THICKNESS	BORE		TEETH
YTB 5 101	150	6 - 12 MM	30	31.75	35 4+4
YTB 5 102	150	8 - 15 MM	30	31.75	35 4+4
YTB 5 103	150	12 - 24 MM	30	31.75	35 4+4
YTB 5 104	150	15 - 29 MM	30	31.75	35 4+4

Any Customized Specifications Also Can Make As Per Requirements



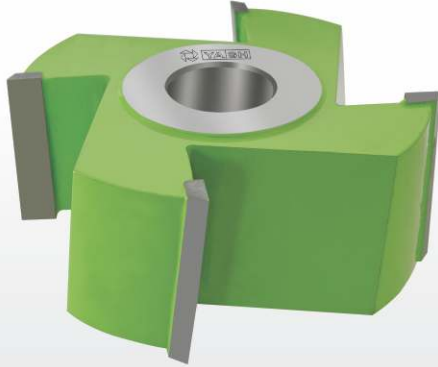

Technical Drawing :

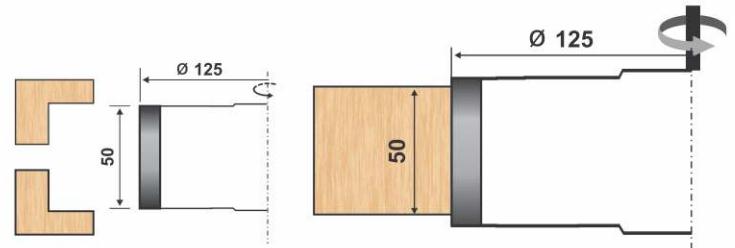

Technical Details :

Spindle Moulder , Four Side Moulder Machines

Application :

Planing , Rebating From Top And From Bottom & Groove .
Perfect Planing In All Materials , But Ideal On Solid Woods,
use in Spindle Moulder Machines , Four Side Moulder Machines .

YTB 6

ORDER CODE	DIA	THICKNESS	BORE			TEETH
YTB 6 101	100	30	30	31.75	35	4
YTB 6 102	100	50	30	31.75	35	4
YTB 6 103	100	75	30	31.75	35	4
YTB 6 104	125	30	30	31.75	35	4
YTB 6 105	125	50	30	31.75	35	4
YTB 6 106	125	75	30	31.75	35	4

Planing Cutter T.C.T (Brazed) - YTB 7



Technical Drawing :

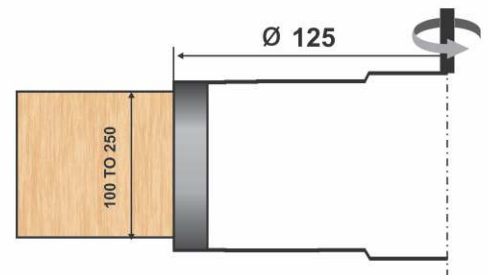

Technical Details :

Used in Spindle Moulder Machines , Four Side Moulder Machines .

Application :

Planing , Rebating From Top And From Bottom & Groove .
Perfect Planing In All Materials , But Ideal On Solid Woods,
use in Spindle Moulder Machines , Four Side Moulder Machines .

YTB 7

ORDER CODE	DIA	THICKNESS	BORE			TEETH
YTB 7 101	125	100	30	31.75	35	4
YTB 7 102	125	125	30	31.75	35	4
YTB 7 103	125	150	30	31.75	35	4
YTB 7 104	125	200	30	31.75	35	4
YTB 7 105	125	250	30	31.75	35	4

Any Customized Specifications Also Can Make As Per Requirements



Technical Details :

Used On: Spindle Moulder Machines

Application :

These very popular design cutters are useful in kitchen shutters. Yash cutters spell a different class in itself. The finish of the wood and cutter life works in your advantage. The cutters can achieve simple or complex profiling.

YTB 8						
ORDER CODE	DIA	THICKNESS	BORE			TEETH
YTB 8 101	125	18-20	30	31.75	35	3
YTB 8 102	125	18-20	30	31.75	35	4
YTB 8 103	125	22-24	30	31.75	35	3
YTB 8 104	125	22-24	30	31.75	35	4
YTB 8 105	125	30-34	30	31.75	35	3
YTB 8 106	125	30-34	30	31.75	35	4

2 PCS. Cutter Set

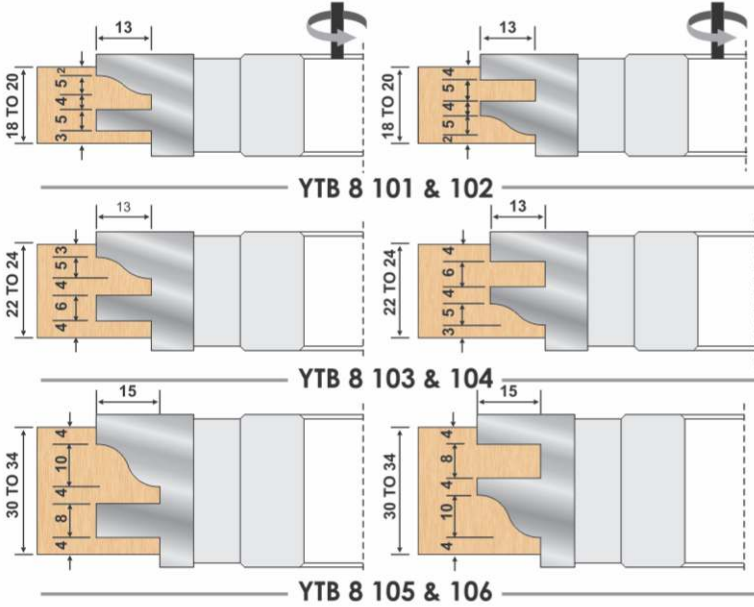

Rail & Style :

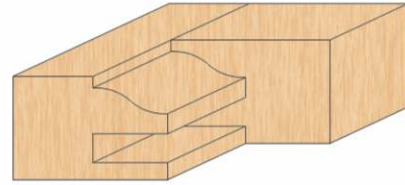

2 PCS. Cutter Set

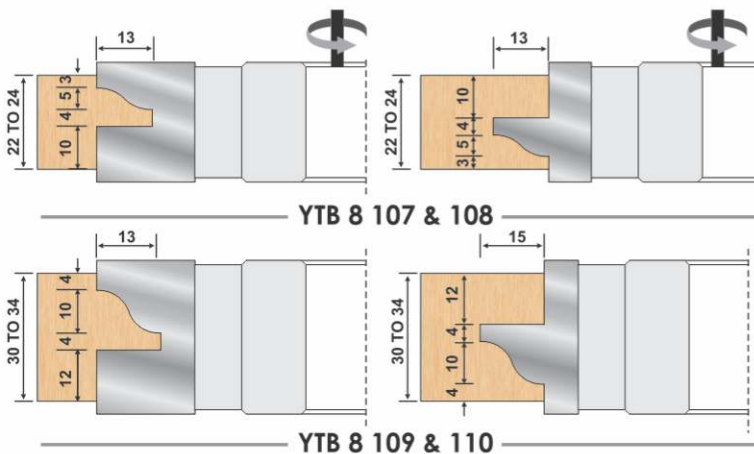

YTB 8 for Window

ORDER CODE	DIA	THICKNESS	BORE			TEETH
YTB 8 107	125	22-24	30	31.75	35	3
YTB 8 108	125	22-24	30	31.75	35	4
YTB 8 109	125	30-34	30	31.75	35	3
YTB 8 110	125	30-34	30	31.75	35	4

Rail & Style :

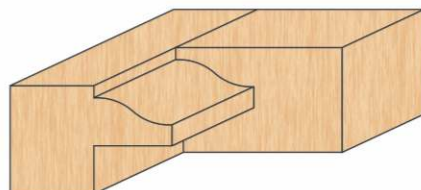

Technical Details :

Used On: Spindle Moulder Machines

Application :

These very popular design cutters are useful in kitchen shutters. Yash cutters spell a different class in itself. The finish of the wood and cutter life works in your advantage. The cutters can achieve simple or complex profiling.



2 PCS. Cutter Set

YTB 9

ORDER CODE	DIA	THICKNESS	BORE			TEETH
YTB 9 101	125	18-20	30	31.75	35	3
YTB 9 102	125	18-20	30	31.75	35	4
YTB 9 103	125	22-24	30	31.75	35	3
YTB 9 104	125	22-24	30	31.75	35	4
YTB 9 105	125	30-34	30	31.75	35	3
YTB 9 106	125	30-34	30	31.75	35	4

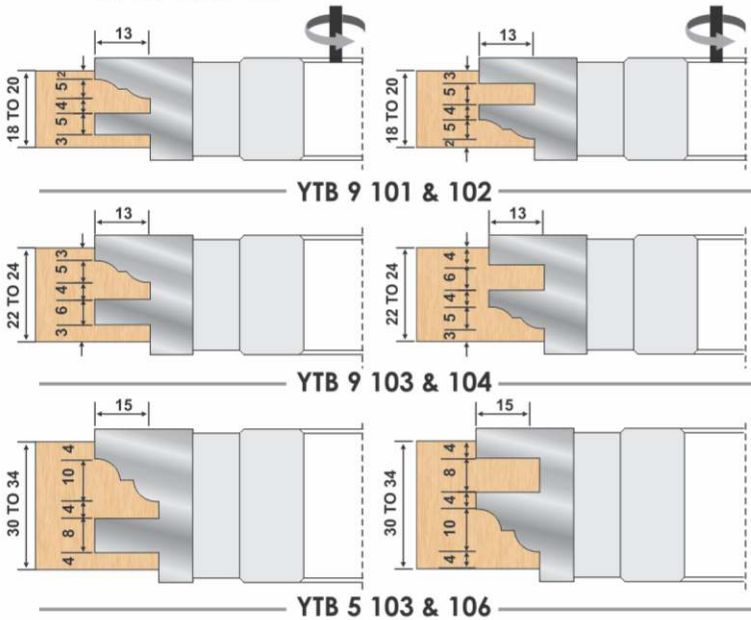

Rail & Style :

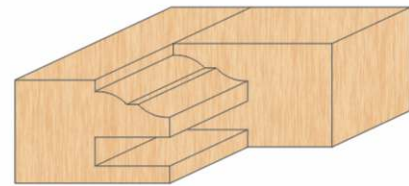

for Window

YTB 9

ORDER CODE	DIA	THICKNESS	BORE			TEETH
YTB 9 107	125	22-24	30	31.75	35	3
YTB 9 108	125	22-24	30	31.75	35	4
YTB 9 109	125	30-34	30	31.75	35	3
YTB 9 110	125	30-34	30	31.75	35	4

2 PCS. Cutter Set

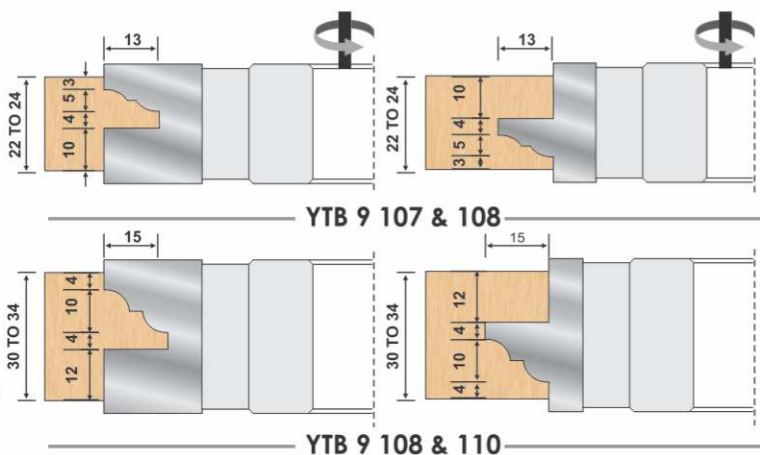

Rail & Style :

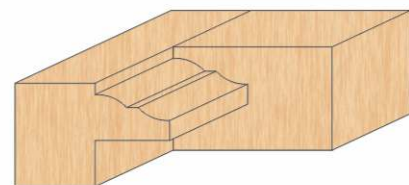

Technical Details :

Used On: Spindle Moulder Machines

Application :

These very popular design cutters are useful in kitchen shutters. Yash cutters spell a different class in itself. The finish of the wood and cutter life works in your advantage. The cutters can achieve simple or complex profiling.



2 PCS. Cutter Set

YTB 10

ORDER CODE	DIA	THICKNESS	BORE			TEETH
YTB 10 101	125	18-20	30	31.75	35	3
YTB 10 102	125	18-20	30	31.75	35	4
YTB 10 103	125	22-24	30	31.75	35	3
YTB 10 104	125	22-24	30	31.75	35	4
YTB 10 105	125	30-34	30	31.75	35	3
YTB 10 106	125	30-34	30	31.75	35	4

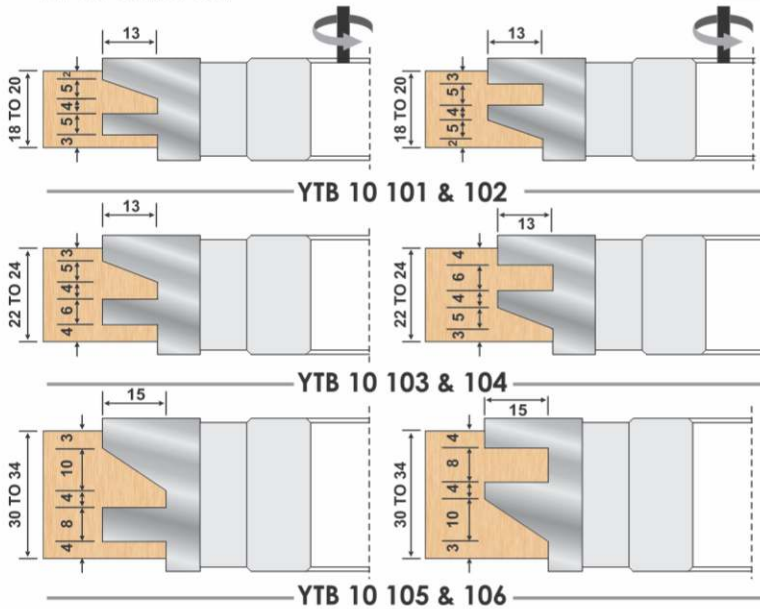

Rail & Style :

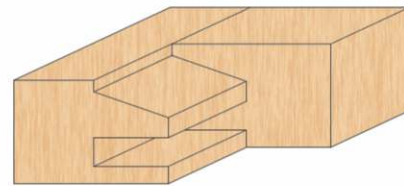

2 PCS. Cutter Set

YTB 10 for Window

ORDER CODE	DIA	THICKNESS	BORE			TEETH
YTB 10 107	125	22-24	30	31.75	35	3
YTB 10 108	125	22-24	30	31.75	35	4
YTB 10 109	125	30-34	30	31.75	35	3
YTB 10 110	125	30-34	30	31.75	35	4

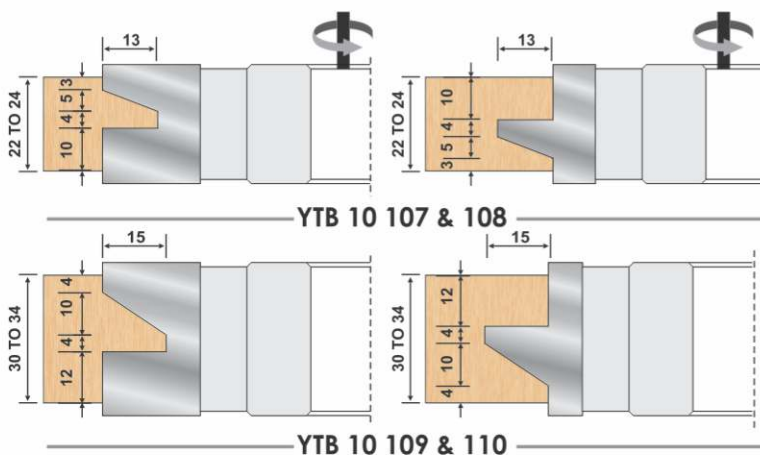

Rail & Style :

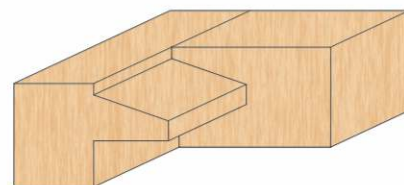

Technical Details :

Used On: Spindle Moulder Machines

Application :

These very popular design cutters are useful in kitchen shutters. Yash cutters spell a different class in itself. The finish of the wood and cutter life works in your advantage. The cutters can achieve simple or complex profiling.

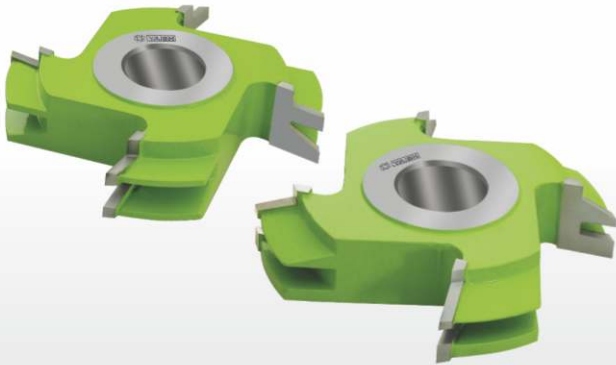

YTB 11						
ORDER CODE	DIA	THICKNESS	BORE			TEETH
YTB 11 101	125	18-20	30	31.75	35	3
YTB 11 102	125	18-20	30	31.75	35	4
YTB 11 103	125	22-24	30	31.75	35	3
YTB 11 104	125	22-24	30	31.75	35	4
YTB 11 105	125	30-34	30	31.75	35	3
YTB 11 106	125	30-34	30	31.75	35	4

2 PCS. Cutter Set

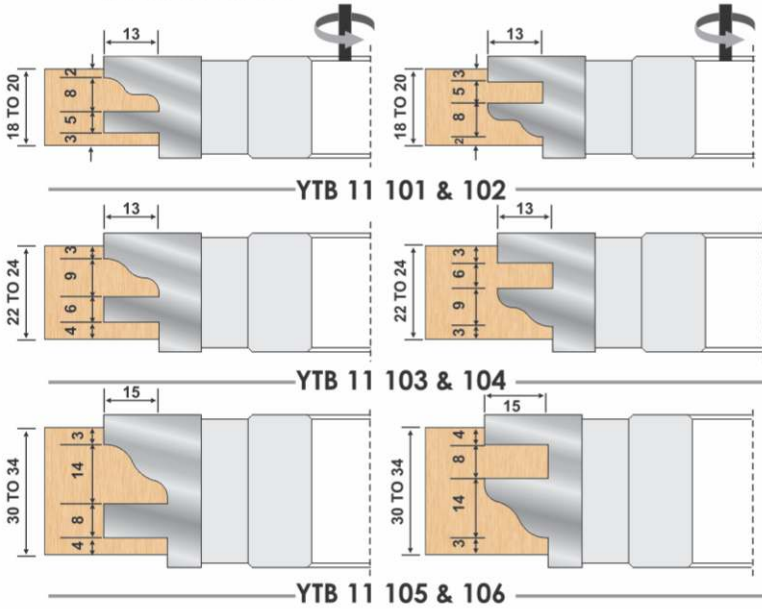

Rail & Style :

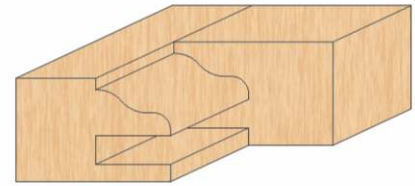

for Window

YTB 11						
ORDER CODE	DIA	THICKNESS	BORE			TEETH
YTB 11 107	125	22-24	30	31.75	35	3
YTB 11 108	125	22-24	30	31.75	35	4
YTB 11 109	125	30-34	30	31.75	35	3
YTB 11 110	125	30-34	30	31.75	35	4

2 PCS. Cutter Set

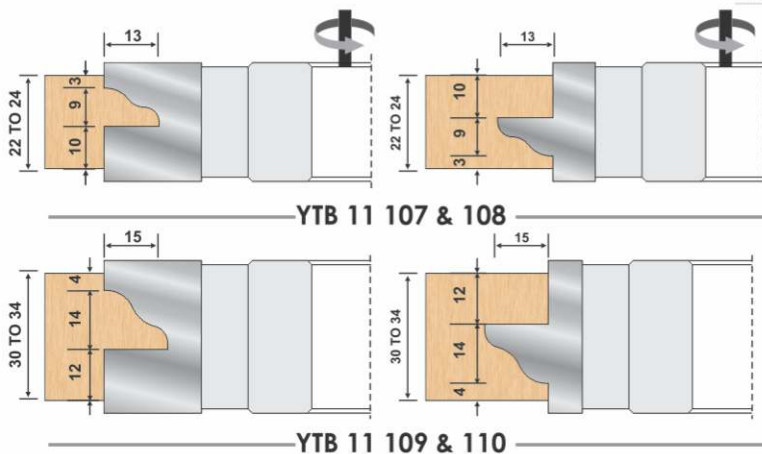

Rail & Style :

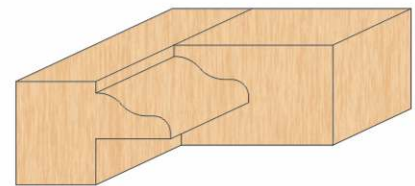

Any Customized Specifications Also Can Make As Per Requirements

Technical Details :

Used On: Spindle Moulder Machines

Application :

These very popular design cutters are useful in kitchen shutters. Yash cutters spell a different class in itself. The finish of the wood and cutter life works in your advantage. The cutters can achieve simple or complex profiling.

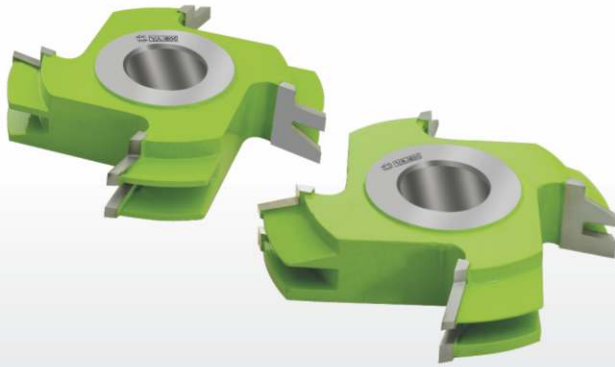

2 PCS. Cutter Set

YTB 12

ORDER CODE	DIA	THICKNESS	BORE			TEETH
YTB 12 101	125	18-20	30	31.75	35	3
YTB 12 102	125	18-20	30	31.75	35	4
YTB 12 103	125	22-24	30	31.75	35	3
YTB 12 104	125	22-24	30	31.75	35	4
YTB 12 105	125	30-34	30	31.75	35	3
YTB 12 106	125	30-34	30	31.75	35	4

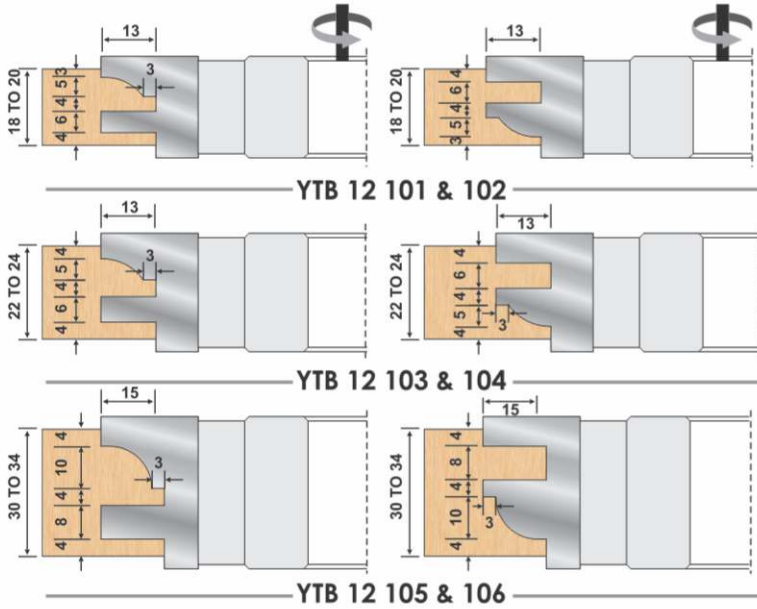

Rail & Style :

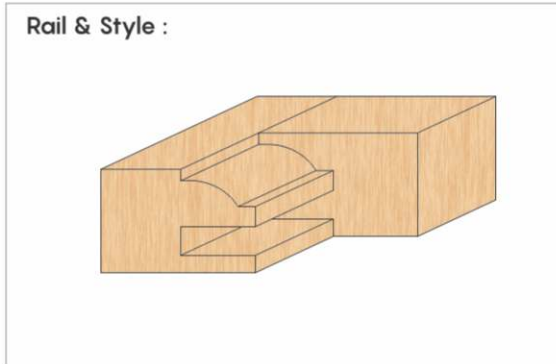

2 PCS. Cutter Set

YTB 12 for Window

ORDER CODE	DIA	THICKNESS	BORE			TEETH
YTB 12 107	125	22-24	30	31.75	35	3
YTB 12 108	125	22-24	30	31.75	35	4
YTB 12 109	125	30-34	30	31.75	35	3
YTB 12 110	125	30-34	30	31.75	35	4

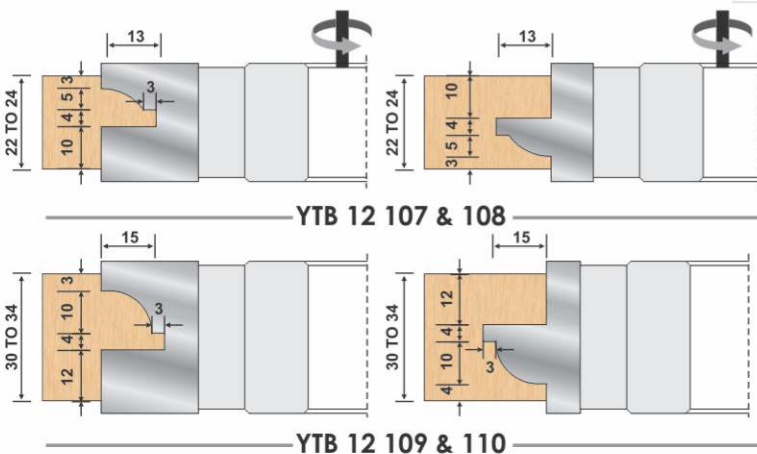

Rail & Style :

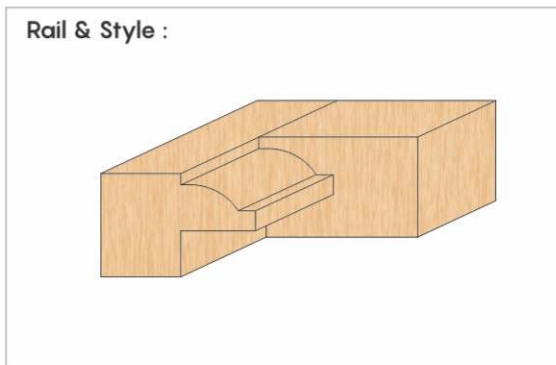



Technical Details :

Used On: Spindle Moulder Machines

Application :

These very popular design cutters are useful in kitchen shutters. Yash cutters spell a different class in itself. The finish of the wood and cutter life works in your advantage. The cutters can achieve simple or complex profiling.

YTB 13						
ORDER CODE	DIA	THICKNESS	BORE			TEETH
YTB 13 101	125	18-20	30	31.75	35	3
YTB 13 102	125	18-20	30	31.75	35	4
YTB 13 103	125	22-24	30	31.75	35	3
YTB 13 104	125	22-24	30	31.75	35	4
YTB 13 105	125	30-34	30	31.75	35	3
YTB 13 106	125	30-34	30	31.75	35	4

2 PCS. Cutter Set

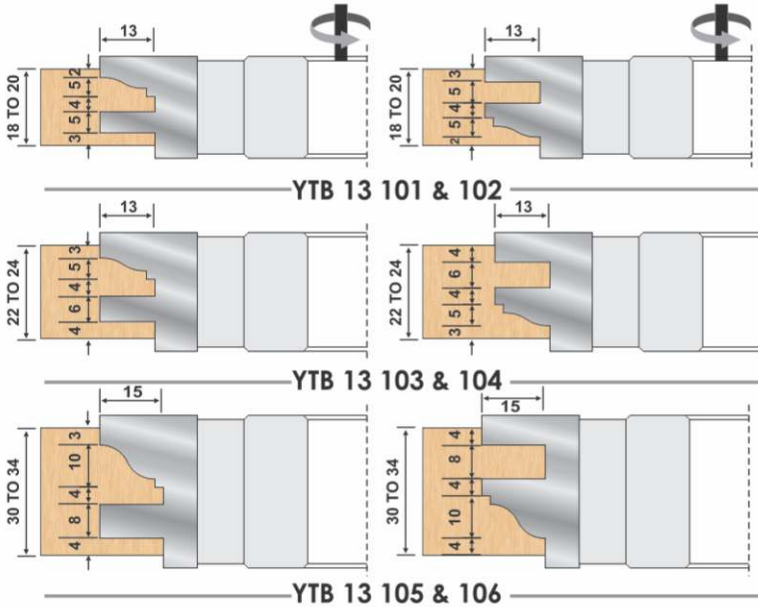

Rail & Style :

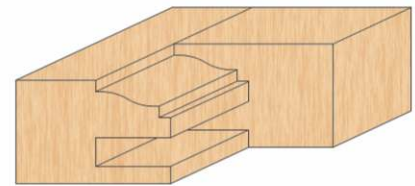

for Window

YTB 13						
ORDER CODE	DIA	THICKNESS	BORE			TEETH
YTB 13 107	125	22-24	30	31.75	35	3
YTB 13 108	125	22-24	30	31.75	35	4
YTB 13 109	125	30-34	30	31.75	35	3
YTB 13 110	125	30-34	30	31.75	35	4

2 PCS. Cutter Set

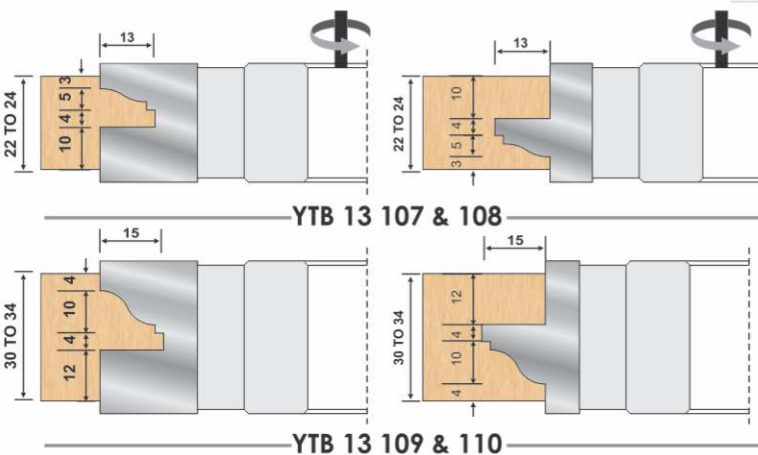

Rail & Style :

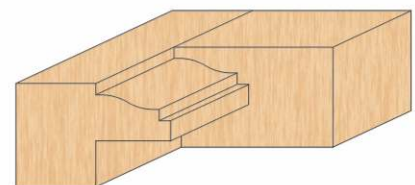

Any Customized Specifications Also Can Make As Per Requirements



Technical Details :

Used On: Spindle Moulder Machines

Application :

These very popular design cutters are useful in kitchen shutters. Yash cutters spell a different class in itself. The finish of the wood and cutter life works in your advantage. The cutters can achieve simple or complex profiling.

YTB 14						
ORDER CODE	DIA	THICKNESS	BORE		TEETH	
YTB 14 101	125	18-25	30	31.75	35	4
YTB 14 102	125	18-25	30	31.75	35	4
YTB 14 103	125	18-25	30	31.75	35	4
YTB 14 104	125	18-25	30	31.75	35	4
YTB 14 105	125	18-25	30	31.75	35	4
YTB 14 106	125	18-25	30	31.75	35	4

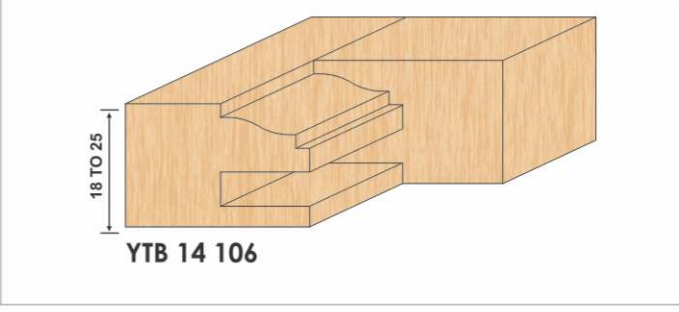
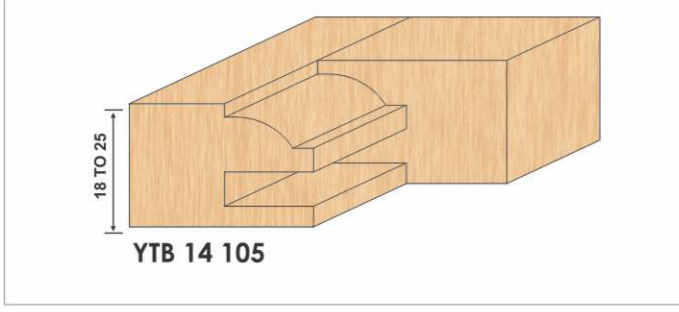
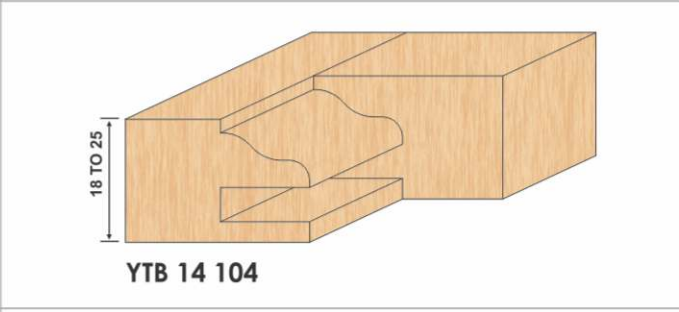
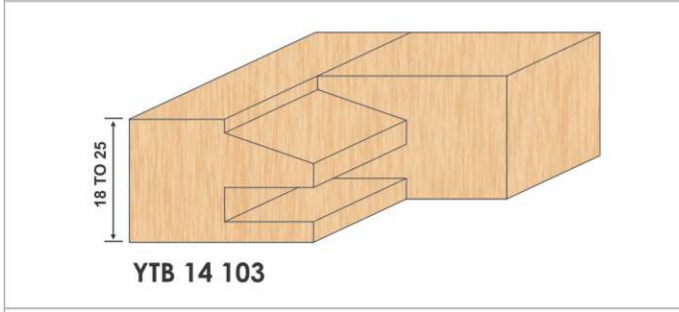
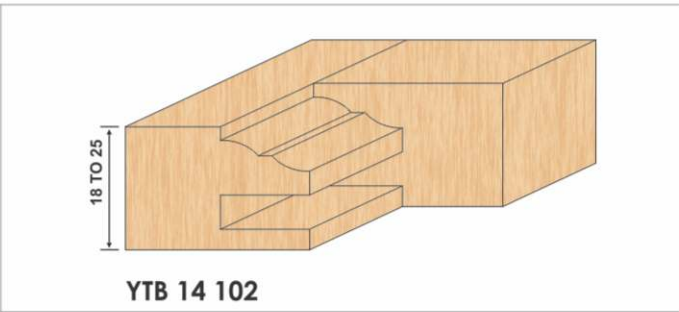
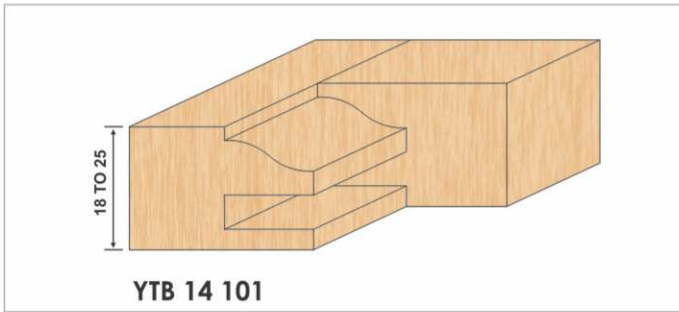
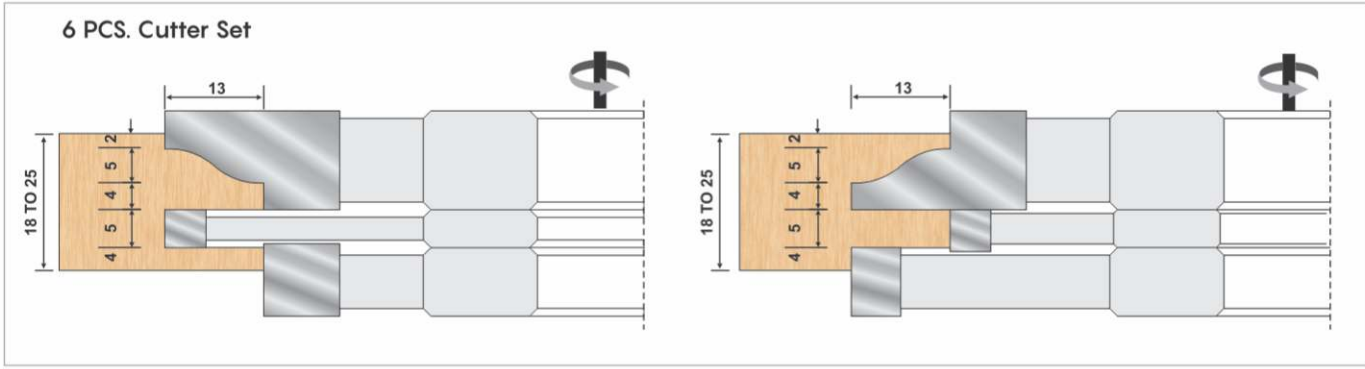

Adjustable Counter Profile Counter For Window T.C.T (Braze) YTB 15



Technical Details :

Spindle Moulder Machines

Application :

These Are Unique Product Made By 4 Pcs . Adjustable Cutter Head Set Ideal For Making Shatters Furniture By Adjusting The Height , Perfectly Profile Fitting , Improve Your Production's Efficiency .

YTB 15						
ORDER CODE	DIA	THICKNESS	BORE		TEETH	
YTB 15 101	125	18-25	30	31.75	35	4
YTB 15 102	125	18-25	30	31.75	35	4
YTB 15 103	125	18-25	30	31.75	35	4
YTB 15 104	125	18-25	30	31.75	35	4
YTB 15 105	125	18-25	30	31.75	35	4
YTB 15 106	125	18-25	30	31.75	35	4

4 PCS. Cutter Set

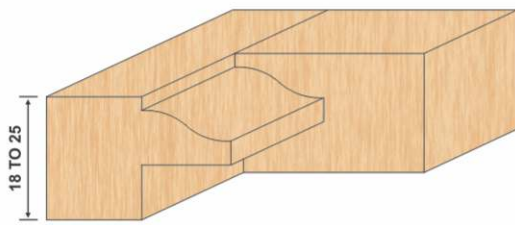
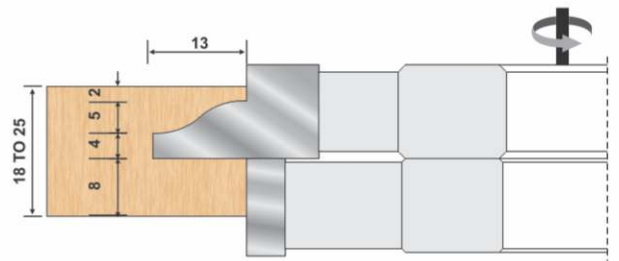
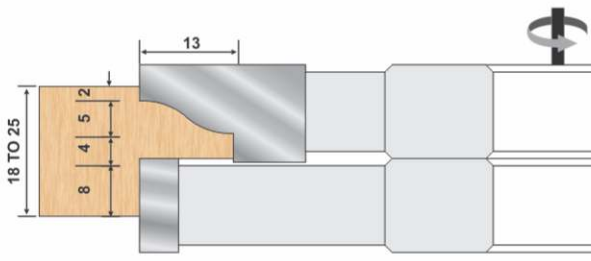

YTB 15 101

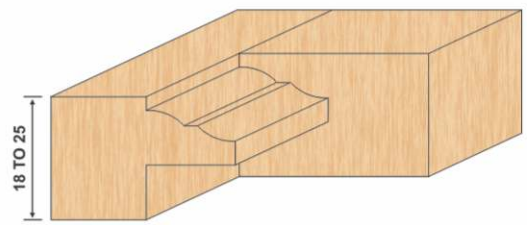

YTB 15 102

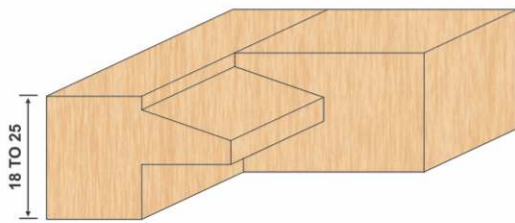

YTB 15 103

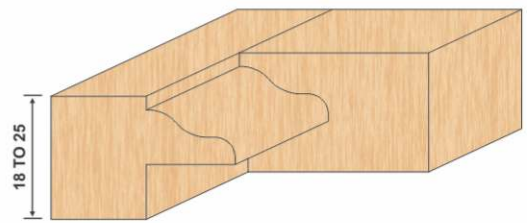

YTB 15 104

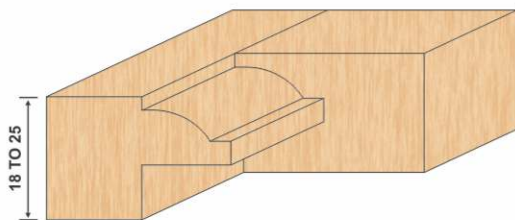

YTB 15 105

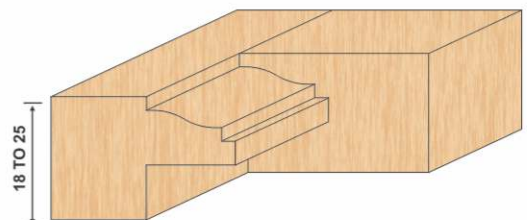

YTB 15 106

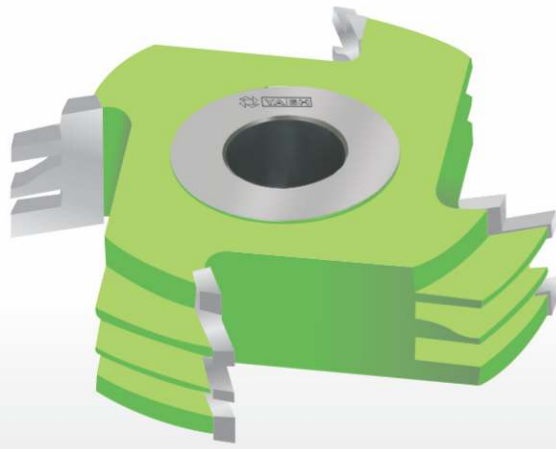

Technical Details :

Spindle Moulder Machines

Application :

These are unique products made by combining two cutter heads, ideal for making furniture doors and drawers. By adjusting the height of the of the cutter head, you can cut two perfectly fitted profiles without wasting time or effort on the fence or replacing the tool. For use on spindle moulder. Perfect on hardwood and panels between 22mm-25mm in thickness.

YTB 16

ORDER CODE	DIA	THICKNESS	BORE		TEETH	
YTB 16 101	125	18-24	30	31.75	35	3
YTB 16 102	125	18-24	30	31.75	35	3
YTB 16 103	125	18-24	30	31.75	35	3
YTB 16 104	125	18-24	30	31.75	35	3
YTB 16 105	125	18-24	30	31.75	35	3
YTB 16 106	125	18-24	30	31.75	35	3
YTB 16 107	125	18-24	30	31.75	35	4
YTB 16 108	125	18-24	30	31.75	35	4
YTB 16 109	125	18-24	30	31.75	35	4
YTB 16 110	125	18-24	30	31.75	35	4
YTB 16 111	125	18-24	30	31.75	35	4
YTB 16 112	125	18-24	30	31.75	35	4

1 PCS. Cutter made male & female profile

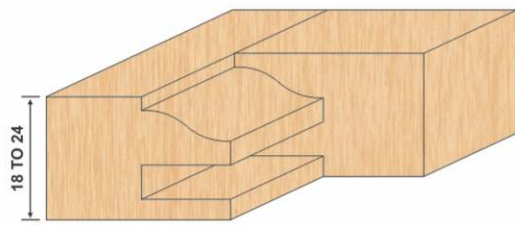
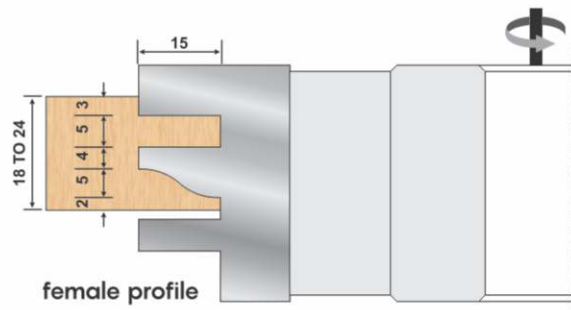
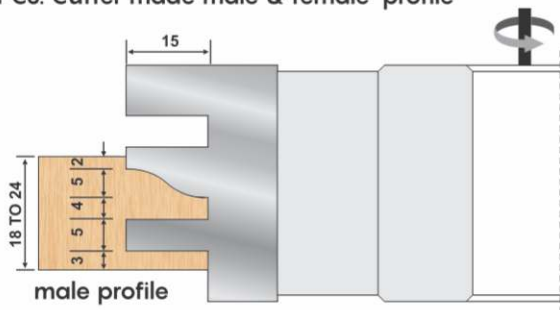

YTB 16 101&107

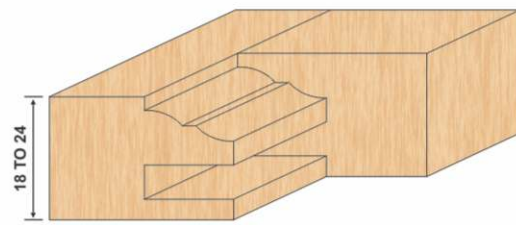

YTB 16 102&108

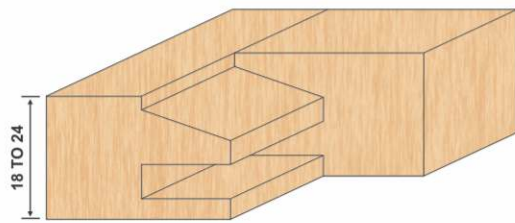

YTB 16 103&109

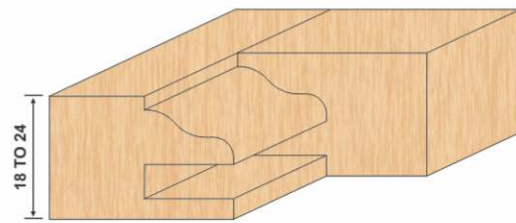

YTB 16 104&110

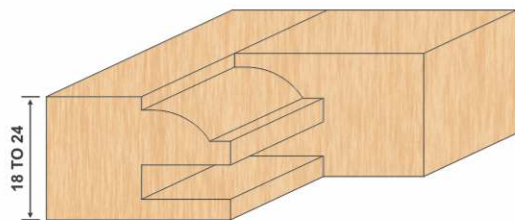

YTB 16 105&111

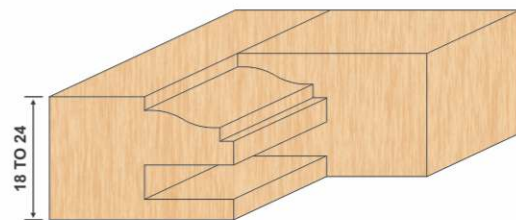

YTB 16 106&112

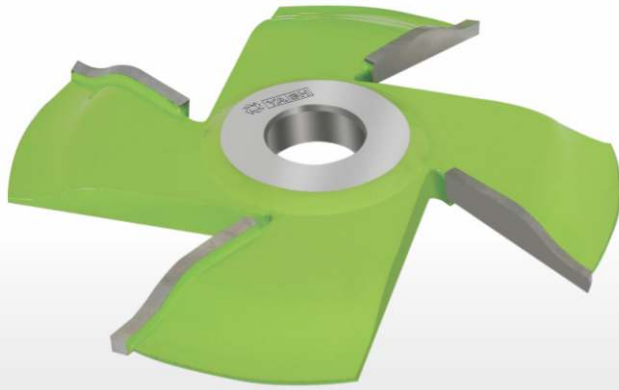

Technical Details :

Spindle Moulder Machines

Application :

These tools produce precise and clean work results, when panel raising in solid wood. To create furniture, door panels, cotted ceilings and paneling. It can cut across and with the grain in hard woods. also useful in resinous Solid Wood and MDF Wood type boards. You can resharpen the blades easily and quickly. The carbide tips are German standards and of 5 mm thickness for longer life.

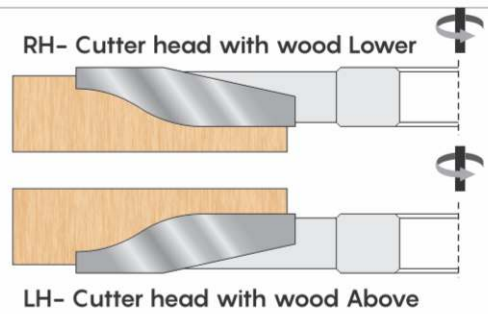

Also Available
Moulding Size 32 x 18 & 50 x 15 & 3 TEETH

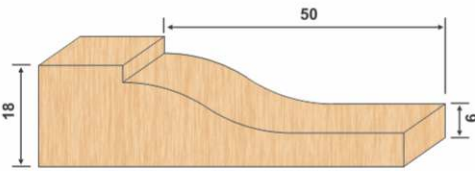

YTB 17							
ORDER CODE		DIA	MOULDING SIZE	BORE			TEETH
YTB 17 101	RH	175	40 x 18	30	31.75	35	4
YTB 17 102	LH	175	40 x 18	30	31.75	35	4
YTB 17 103	RH	175	50 x 18	30	31.75	35	4
YTB 17 104	LH	175	50 x 18	30	31.75	35	4

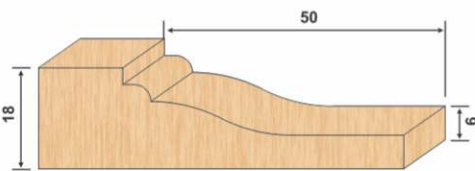

YTB 17							
ORDER CODE		DIA	MOULDING SIZE	BORE			TEETH
YTB 17 105	RH	175	40 x 18	30	31.75	35	4
YTB 17 106	LH	175	40 x 18	30	31.75	35	4
YTB 17 107	RH	175	50 x 18	30	31.75	35	4
YTB 17 108	LH	175	50 x 18	30	31.75	35	4

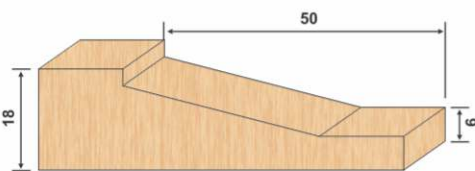

YTB 17							
ORDER CODE		DIA	MOULDING SIZE	BORE			TEETH
YTB 17 109	RH	175	40 x 18	30	31.75	35	4
YTB 17 110	LH	175	40 x 18	30	31.75	35	4
YTB 17 111	RH	175	50 x 18	30	31.75	35	4
YTB 17 112	LH	175	50 x 18	30	31.75	35	4

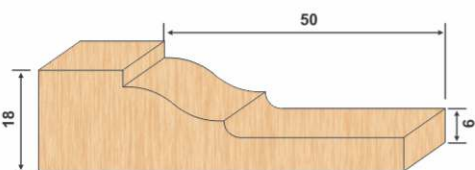

YTB 17							
ORDER CODE		DIA	MOULDING SIZE	BORE			TEETH
YTB 17 113	RH	175	40 x 18	30	31.75	35	4
YTB 17 114	LH	175	40 x 18	30	31.75	35	4
YTB 17 115	RH	175	50 x 18	30	31.75	35	4
YTB 17 116	LH	175	50 x 18	30	31.75	35	4

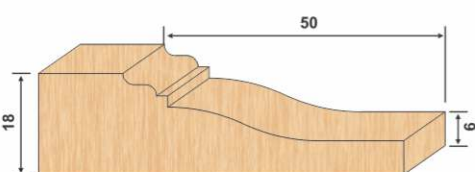

YTB 17							
ORDER CODE		DIA	MOULDING SIZE	BORE			TEETH
YTB 17 117	RH	175	40 x 18	30	31.75	35	4
YTB 17 118	LH	175	40 x 18	30	31.75	35	4
YTB 17 119	RH	175	50 x 18	30	31.75	35	4
YTB 17 120	LH	175	50 x 18	30	31.75	35	4

Also Available Moulding Size 32 x 18 & 50 x 15 3 TEETH

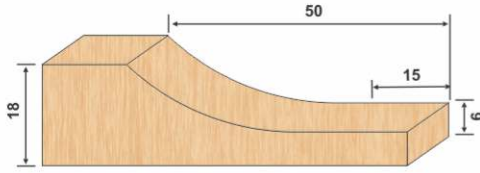

YTB 17							
ORDER CODE		DIA	MOULDING SIZE	BORE			TEETH
YTB 17 121	RH	175	40 x 18	30	31.75	35	4
YTB 17 122	LH	175	40 x 18	30	31.75	35	4
YTB 17 123	RH	175	50 x 18	30	31.75	35	4
YTB 17 124	LH	175	50 x 18	30	31.75	35	4

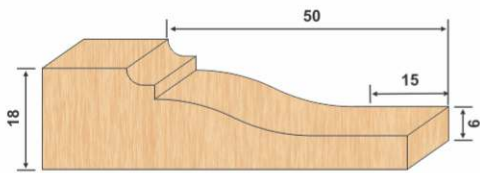

YTB 17							
ORDER CODE		DIA	MOULDING SIZE	BORE			TEETH
YTB 17 125	RH	175	40 x 18	30	31.75	35	4
YTB 17 126	LH	175	40 x 18	30	31.75	35	4
YTB 17 127	RH	175	50 x 18	30	31.75	35	4
YTB 17 128	LH	175	50 x 18	30	31.75	35	4

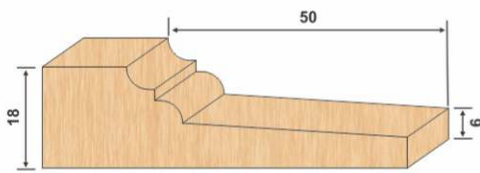

YTB 17							
ORDER CODE		DIA	MOULDING SIZE	BORE			TEETH
YTB 17 129	RH	175	40 x 18	30	31.75	35	4
YTB 17 130	LH	175	40 x 18	30	31.75	35	4
YTB 17 131	RH	175	50 x 18	30	31.75	35	4
YTB 17 132	LH	175	50 x 18	30	31.75	35	4

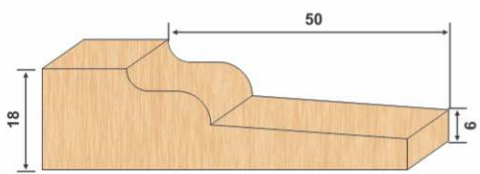

YTB 17							
ORDER CODE		DIA	MOULDING SIZE	BORE			TEETH
YTB 17 133	RH	175	40 x 18	30	31.75	35	4
YTB 17 134	LH	175	40 x 18	30	31.75	35	4
YTB 17 135	RH	175	50 x 18	30	31.75	35	4
YTB 17 136	LH	175	50 x 18	30	31.75	35	4

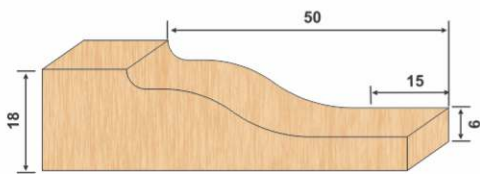

YTB 17							
ORDER CODE		DIA	MOULDING SIZE	BORE			TEETH
YTB 17 137	RH	175	40 x 18	30	31.75	35	4
YTB 17 138	LH	175	40 x 18	30	31.75	35	4
YTB 17 139	RH	175	50 x 18	30	31.75	35	4
YTB 17 140	LH	175	50 x 18	30	31.75	35	4

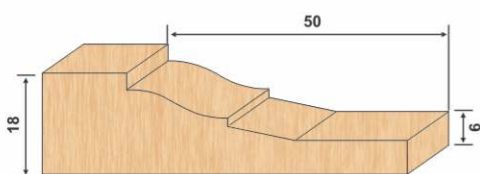

YTB 17							
ORDER CODE		DIA	MOULDING SIZE	BORE			TEETH
YTB 17 141	RH	175	40 x 18	30	31.75	35	4
YTB 17 142	LH	175	40 x 18	30	31.75	35	4
YTB 17 143	RH	175	50 x 18	30	31.75	35	4
YTB 17 144	LH	175	50 x 18	30	31.75	35	4

Raised Panel Cutter Head For Door (2Pcs Set) T.C.T (Brazed) - YTB 18



Technical Details :

Spindle Moulder Machines

Application :

These tools produce precise and clean work results, when panel raising in solid wood. To create furniture, door panels, cotted ceilings and paneling. It can cut across and with the grain in hard woods. also useful in resinous Solid Wood and MDF Wood type boards. You can resharpen the blades easily and quickly. The carbide tips are German standards and of 5 mm thickness for longer life.

RH- Cutter head with wood Lower

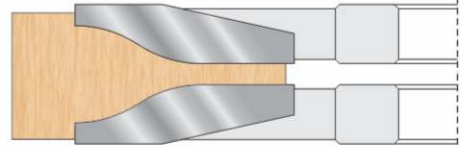

LH- Cutter head with wood Above

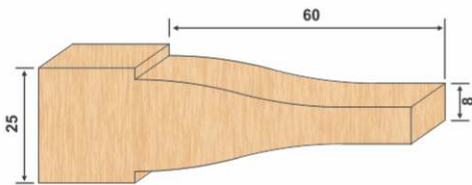

YTB 18

ORDER CODE	DIA	MOULDING SIZE	BORE			TEETH
YTB 18 101	175	50 x 25	30	31.75	35	4
YTB 18 102	175	60 x 25	30	31.75	35	4

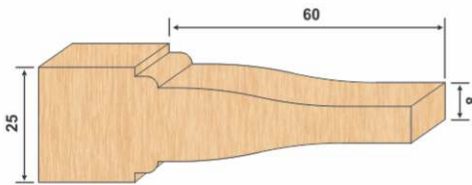

YTB 18

ORDER CODE	DIA	MOULDING SIZE	BORE			TEETH
YTB 18 103	175	50 x 25	30	31.75	35	4
YTB 18 104	175	60 x 25	30	31.75	35	4

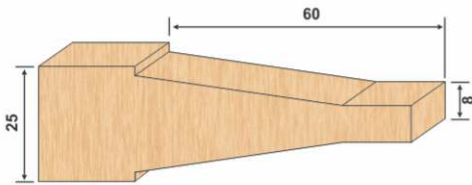

YTB 18

ORDER CODE	DIA	MOULDING SIZE	BORE			TEETH
YTB 18 105	175	50 x 25	30	31.75	35	4
YTB 18 106	175	60 x 25	30	31.75	35	4

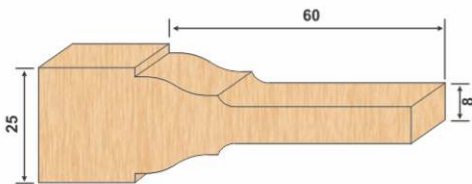

YTB 18

ORDER CODE	DIA	MOULDING SIZE	BORE			TEETH
YTB 18 107	175	50 x 25	30	31.75	35	4
YTB 18 108	175	60 x 25	30	31.75	35	4

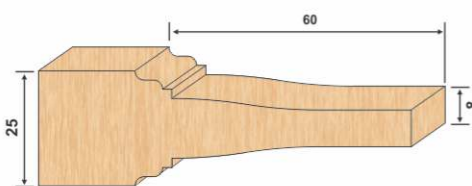

YTB 18

ORDER CODE	DIA	MOULDING SIZE	BORE			TEETH
YTB 18 109	175	50 x 25	30	31.75	35	4
YTB 18 110	175	60 x 25	30	31.75	35	4

Raised Panel Cutter Head For Door (2Pcs Set)
T.C.T (Brazed) - YTB 18

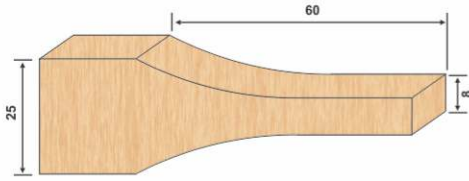

YTB 18

ORDER CODE	DIA	MOULDING SIZE	BORE			TEETH
YTB 18 111	175	50 x 25	30	31.75	35	4
YTB 18 112	175	60 x 25	30	31.75	35	4

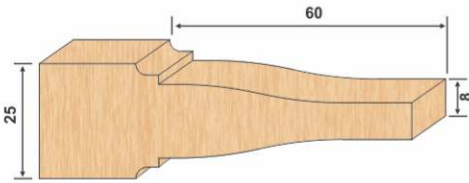

YTB 18

ORDER CODE	DIA	MOULDING SIZE	BORE			TEETH
YTB 18 113	175	50 x 25	30	31.75	35	4
YTB 18 114	175	60 x 25	30	31.75	35	4

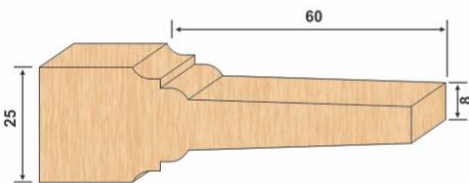

YTB 18

ORDER CODE	DIA	MOULDING SIZE	BORE			TEETH
YTB 18 115	175	50 x 25	30	31.75	35	4
YTB 18 116	175	60 x 25	30	31.75	35	4

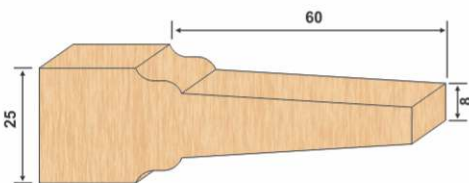

YTB 18

ORDER CODE	DIA	MOULDING SIZE	BORE			TEETH
YTB 18 117	175	50 x 25	30	31.75	35	4
YTB 18 118	175	60 x 25	30	31.75	35	4

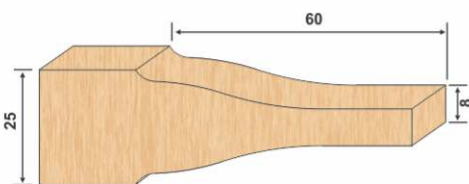

YTB 18

ORDER CODE	DIA	MOULDING SIZE	BORE			TEETH
YTB 18 119	175	50 x 25	30	31.75	35	4
YTB 18 120	175	60 x 25	30	31.75	35	4

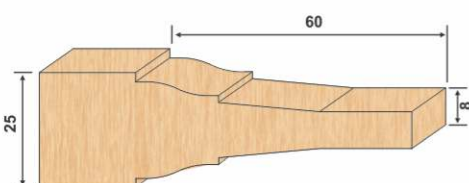

YTB 18

ORDER CODE	DIA	MOULDING SIZE	BORE			TEETH
YTB 18 121	175	50 x 25	30	31.75	35	4
YTB 18 122	175	60 x 25	30	31.75	35	4

Cutter Head Set for Door Extra Long Tenon T.C.T (Brazed) - YTB 19 (5 Pcs Set)

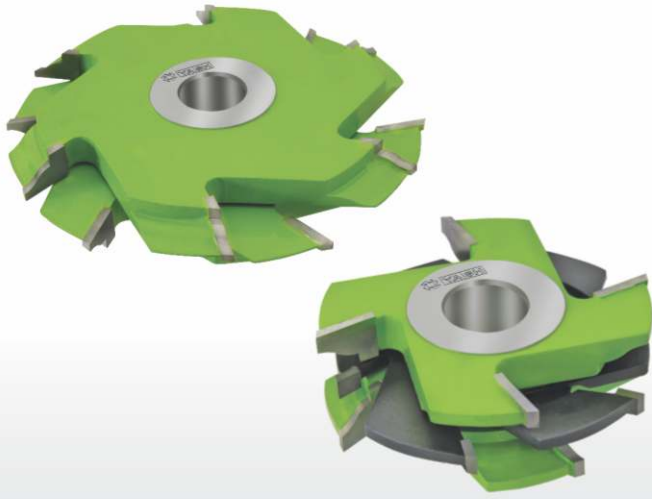

Technical Details :
Spindle Moulder Machines

Application :
These very popular design cutters are useful in Door shutters. Yash cutters spell a different class in itself. The finish of the wood and cutter life works in your advantage. The cutters can achieve simple or complex profiling.

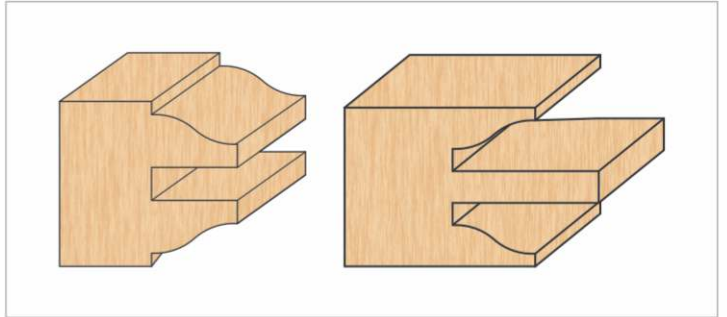

YTB 19						
ORDER CODE	DIA	WOOD THICKNESS	BORE			TEETH
YTB 19 101	125 / 200	32 to 40	30	31.75	35	4 + 6
YTB 19 102	125 / 200	32 to 40	30	31.75	35	4 + 6
YTB 19 103	125 / 200	32 to 40	30	31.75	35	4 + 6
YTB 19 104	125 / 200	32 to 40	30	31.75	35	4 + 6
YTB 19 105	125 / 200	32 to 40	30	31.75	35	4 + 6
YTB 19 106	125 / 200	32 to 40	30	31.75	35	4 + 6

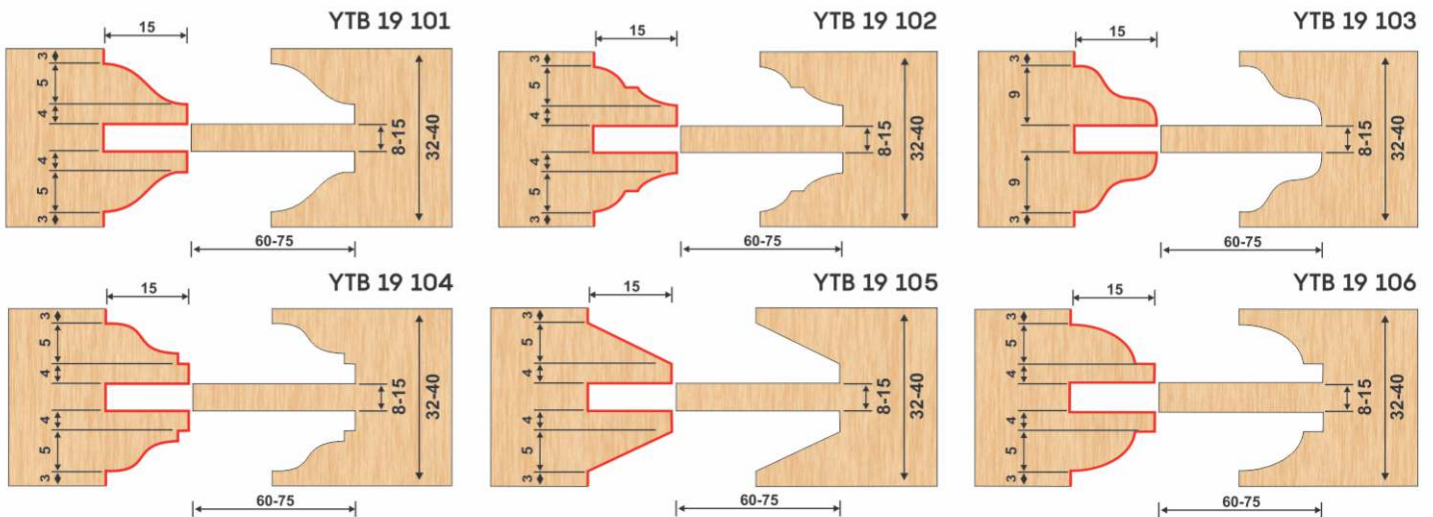
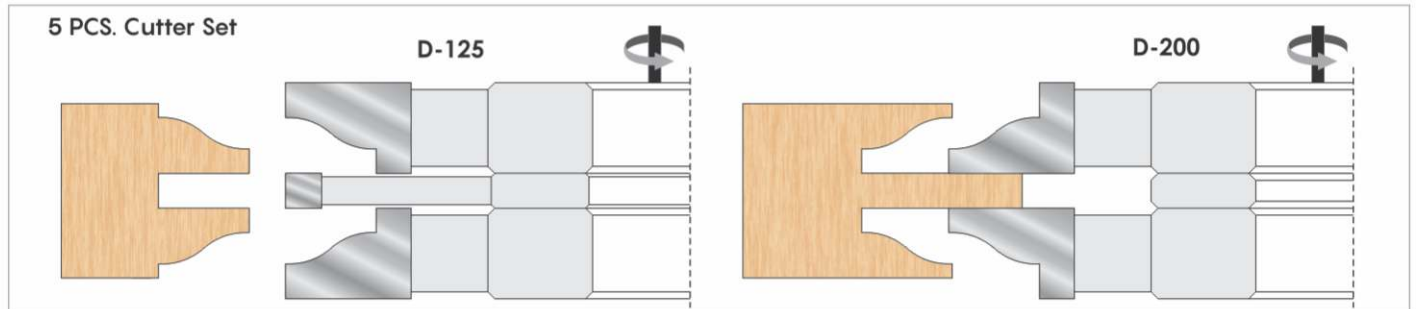

for Making Window Frame

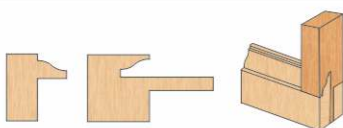

ORDER CODE
YTB 19 01
D-170 x B30 x T20 x Z6

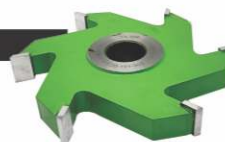

ORDER CODE
YTB 19 02
D-125 x B30 x T20 x Z4



Any Customized Specifications Also Can Make As Per Requirements

Cutter Head Set for Door Extra Long Tenon T.C.T (Brazed) - YTB 20 (5 Pcs Set)

Technical Details :

Spindle Moulder Machines

Application :

These very popular design cutters are useful in Door shutters. Yash cutters spell a different class in itself. The finish of the wood and cutter life works in your advantage. The cutters can achieve simple or complex profiling.

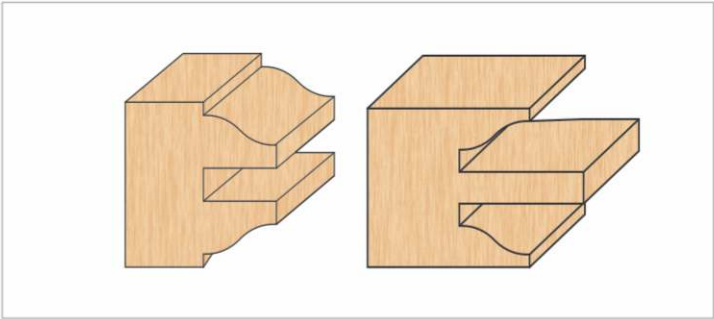
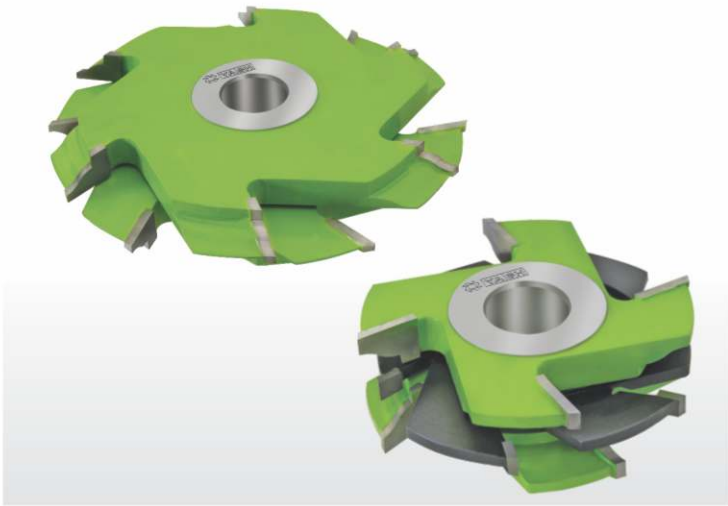

YTB 20						
ORDER CODE	DIA	WOOD THICKNESS	BORE			TEETH
YTB 20 101	125 / 200	40 to 50	30	31.75	35	4 + 6
YTB 20 102	125 / 200	40 to 50	30	31.75	35	4 + 6
YTB 20 103	125 / 200	40 to 50	30	31.75	35	4 + 6
YTB 20 104	125 / 200	40 to 50	30	31.75	35	4 + 6
YTB 20 105	125 / 200	40 to 50	30	31.75	35	4 + 6
YTB 20 106	125 / 200	40 to 50	30	31.75	35	4 + 6

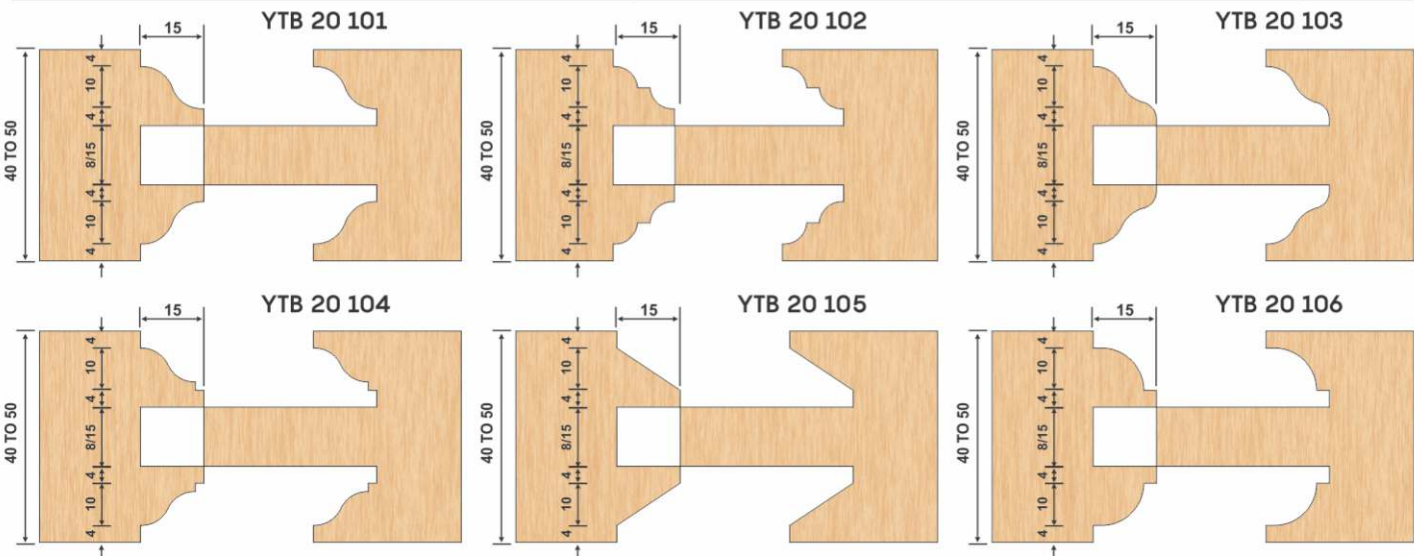
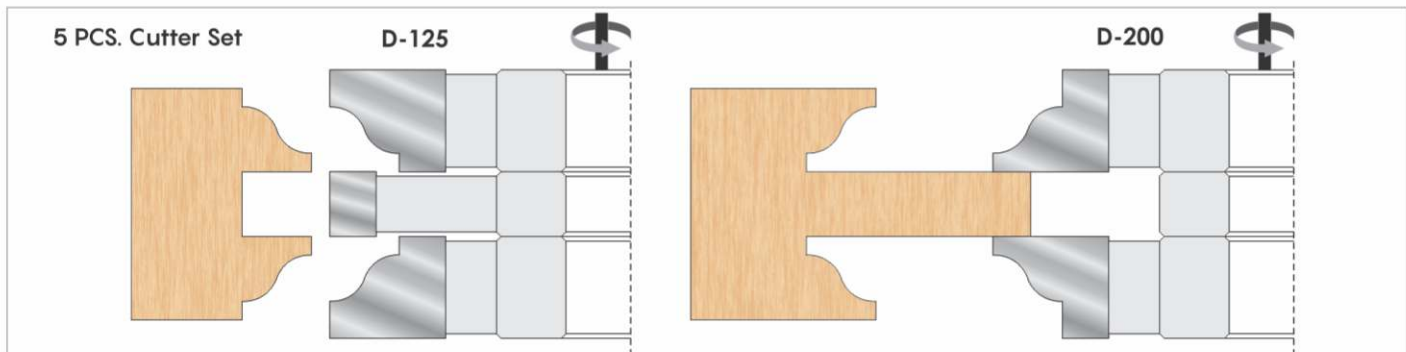

for Making Window Frame

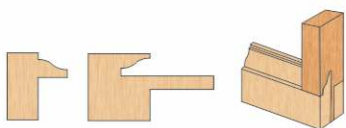

ORDER CODE
YTB 20 01
D-170 x B30 x T20 x Z6

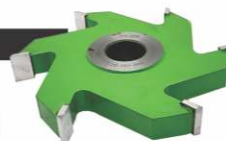

ORDER CODE
YTB 20 02
D-125 x B30 x T20 x Z4

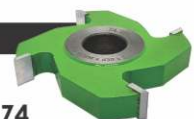

Cutter Head Set for Door Short Tenon
T.C.T (Brazed) - YTB 21 (5 Pcs Set)



Technical Details :

Spindle Moulder Machines

Application :

These very popular design cutters are useful in Door shutters. Yash cutters spell a different class in itself. The finish of the wood and cutter life works in your advantage. The cutters can achieve simple or complex profiling.

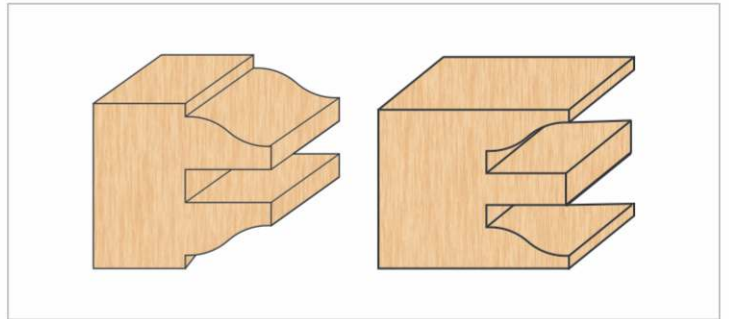

YTB 21						
ORDER CODE	DIA	WOOD THICKNESS	BORE			TEETH
YTB 21 101	125	32 to 40	30	31.75	35	4
YTB 21 102	125	32 to 40	30	31.75	35	4
YTB 21 103	125	32 to 40	30	31.75	35	4
YTB 21 104	125	32 to 40	30	31.75	35	4
YTB 21 105	125	32 to 40	30	31.75	35	4
YTB 21 106	125	32 to 40	30	31.75	35	4

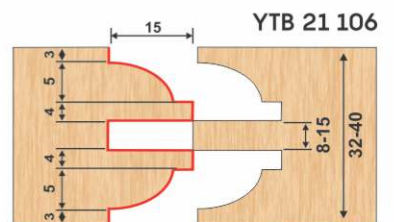
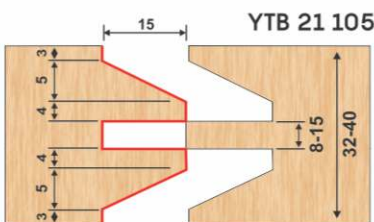
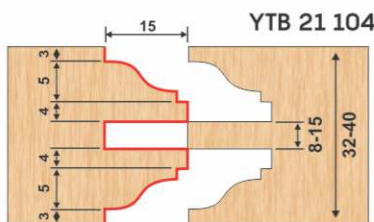
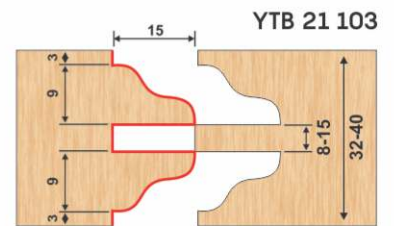
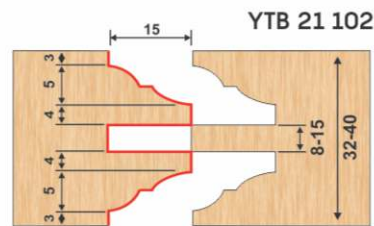
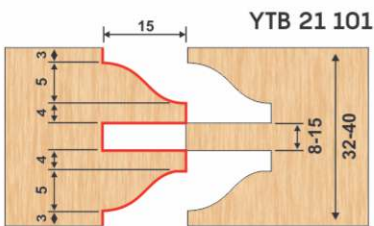
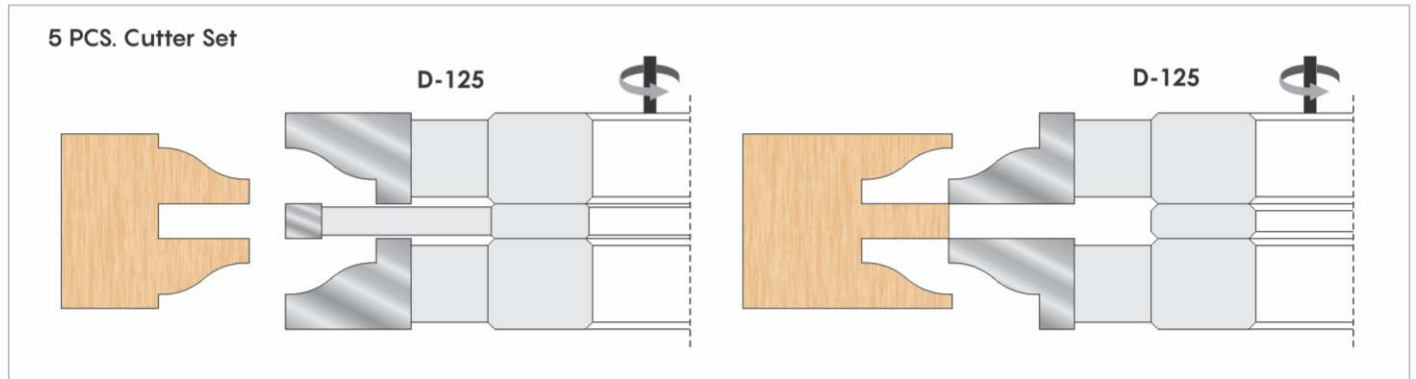

Cutter Head Set for Window T.C.T (Brazed) - YTB 22 (4 Pcs Set)

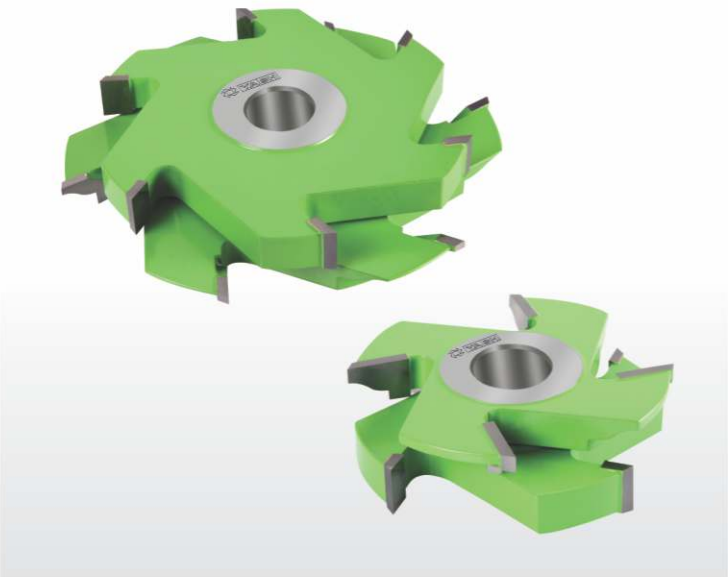

Technical Details :
Spindle Moulder Machines

Application :
These very popular design cutters are useful in Window shutters. Yash cutters spell a different class in itself. The finish of the wood and cutter life works in your advantage. The cutters can achieve simple or complex profiling.

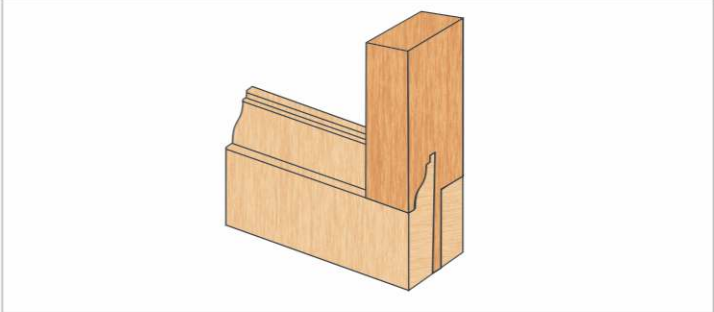

YTB 22							
ORDER CODE	DIA	WOOD THICKNESS	BORE		TEETH		
YTB 22 101	125 / 170 / 200	32 to 40	30	31.75	35	4 / 6	
YTB 22 102	125 / 170 / 200	32 to 40	30	31.75	35	4 / 6	
YTB 22 103	125 / 170 / 200	32 to 40	30	31.75	35	4 / 6	
YTB 22 104	125 / 170 / 200	32 to 40	30	31.75	35	4 / 6	
YTB 22 105	125 / 170 / 200	32 to 40	30	31.75	35	4 / 6	
YTB 22 106	125 / 170 / 200	32 to 40	30	31.75	35	4 / 6	

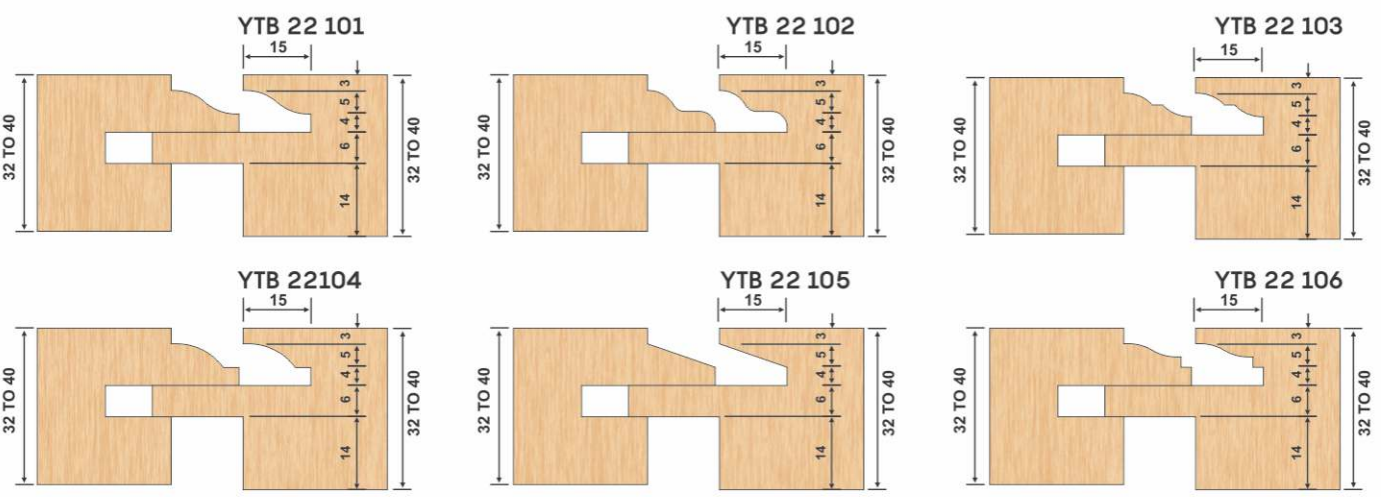
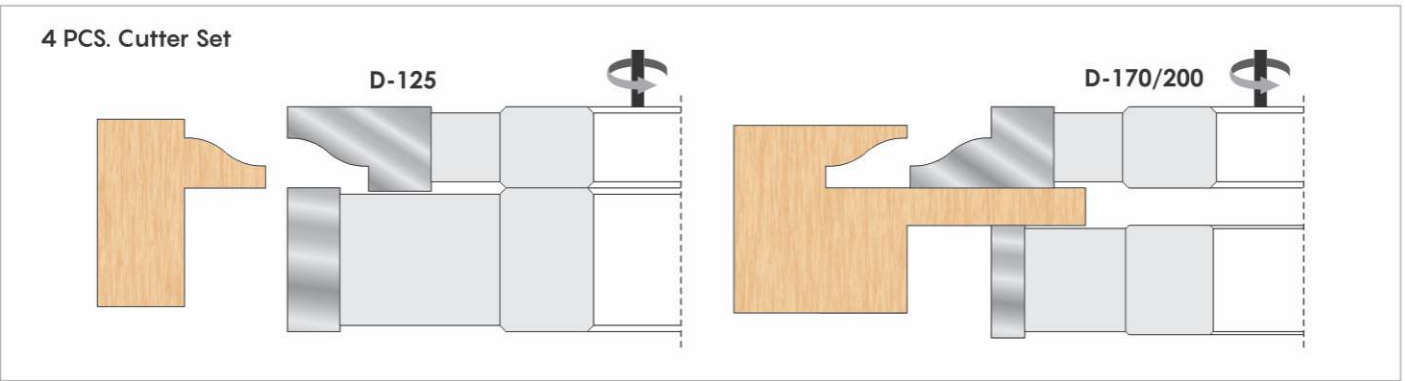

Cutter Head Door Set for Tenoning T.C.T (Brazed) - YTB 23 (5 Pcs Set)

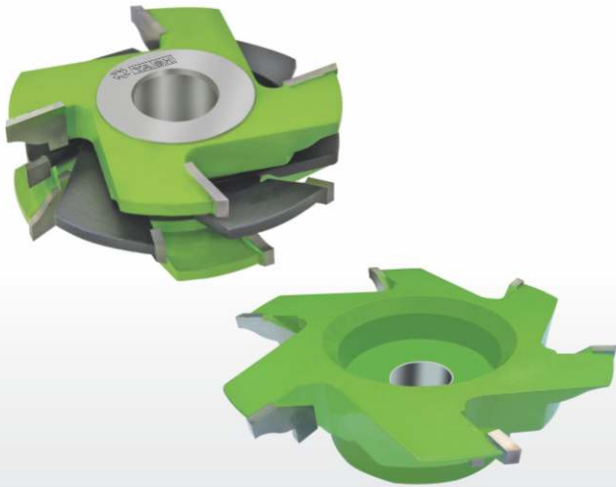

Technical Details :

Tenoning Machines & Spindle Moulder Machines,

Application :

These very popular design cutters are useful in Door shutters. Yash cutters spell a different class in itself. The finish of the wood and cutter life works in your advantage. The cutters can achieve simple or complex profiling.

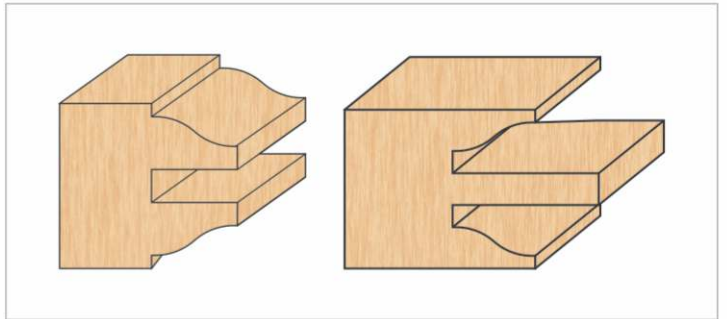

YTB 23						
ORDER CODE	DIA	WOOD THICKNESS	BORE			TEETH
YTB 23 101	125 / 150	32 to 40	30	31.75	35	4 / 6
YTB 23 102	125 / 150	32 to 40	30	31.75	35	4 / 6
YTB 23 103	125 / 150	32 to 40	30	31.75	35	4 / 6
YTB 23 104	125 / 150	32 to 40	30	31.75	35	4 / 6
YTB 23 105	125 / 150	32 to 40	30	31.75	35	4 / 6
YTB 23 106	125 / 150	32 to 40	30	31.75	35	4 / 6

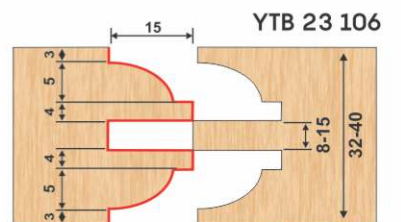
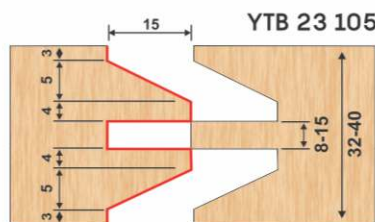
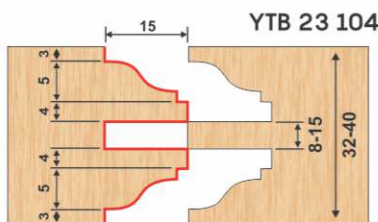
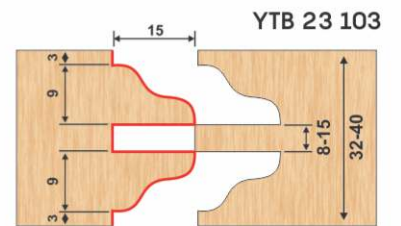
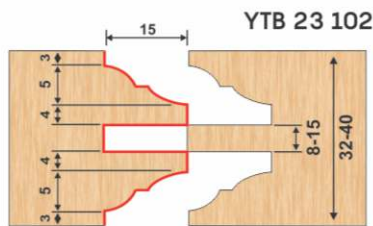
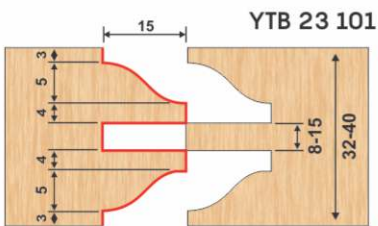
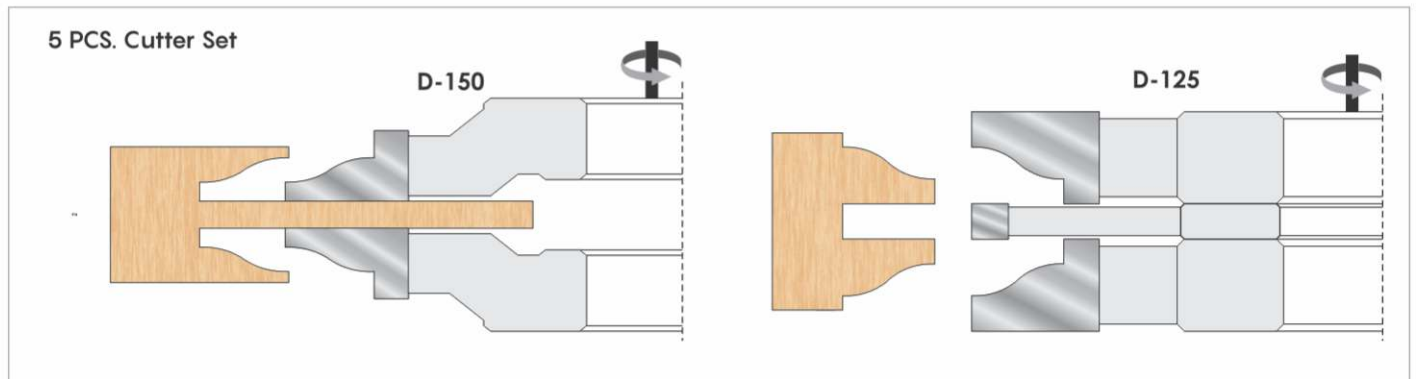

Cutter Head Set Window for Tenoning T.C.T (Brazed) - YTB 24 (4 Pcs Set)

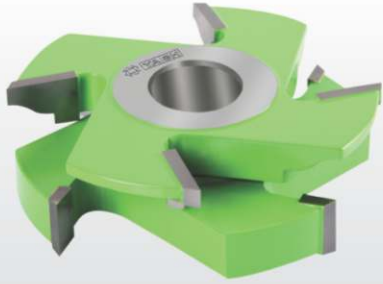

Technical Details :

Tenoning Machines & Spindle Moulder Machines

Application :

These very popular design cutters are useful in Door shutters. Yash cutters spell a different class in itself. The finish of the wood and cutter life works in your advantage. The cutters can achieve simple or complex profiling.

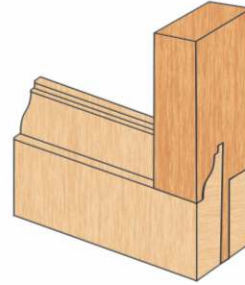

YTB 24

ORDER CODE	DIA	WOOD THICKNESS	BORE		TEETH
YTB 24 101	125 / 150	32 to 40	30	31.75	35 4 / 6
YTB 24 102	125 / 150	32 to 40	30	31.75	35 4 / 6
YTB 24 103	125 / 150	32 to 40	30	31.75	35 4 / 6
YTB 24 104	125 / 150	32 to 40	30	31.75	35 4 / 6
YTB 24 105	125 / 150	32 to 40	30	31.75	35 4 / 6
YTB 24 106	125 / 150	32 to 40	30	31.75	35 4 / 6

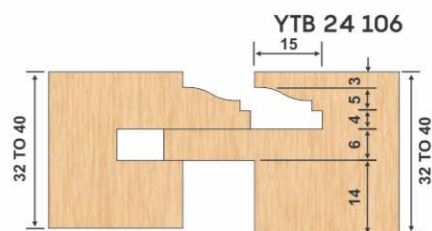
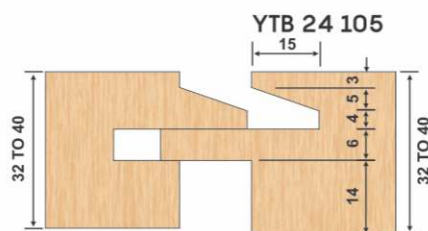
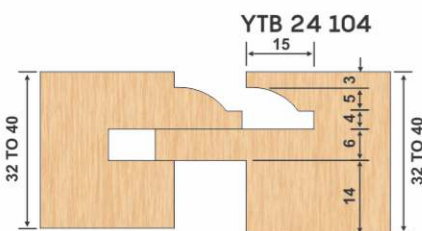
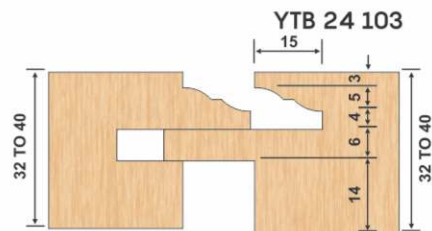
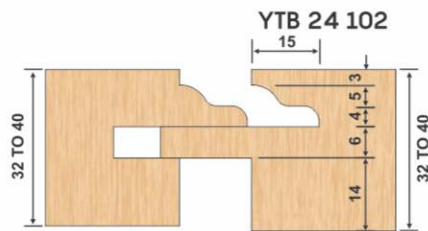
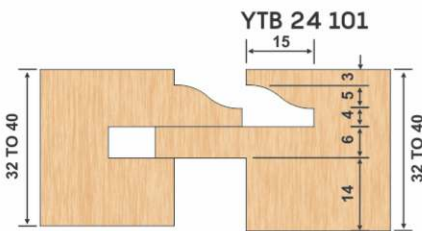
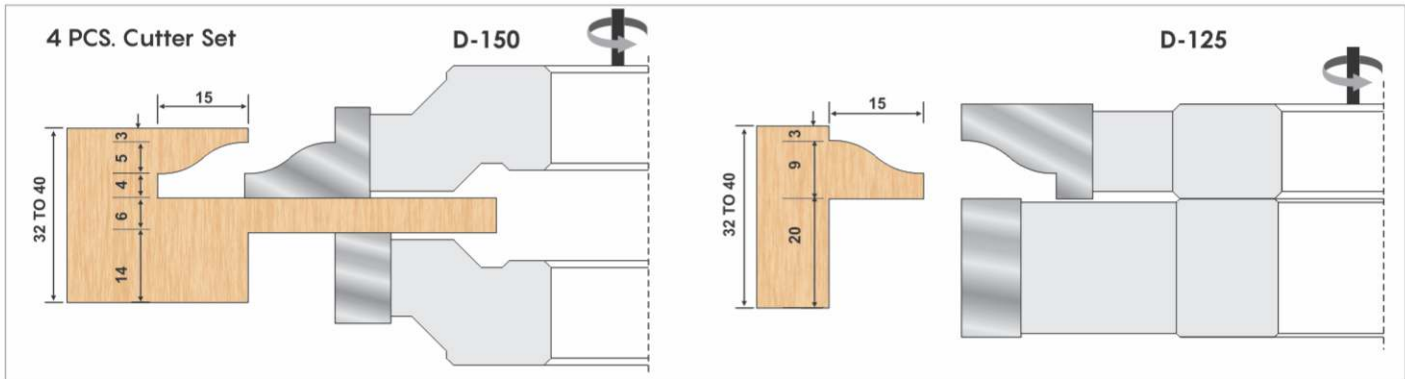

Cutter Head Set for Door Fix T.C.T (Brazed) - YTB 24 A (2 Pcs Set)



Technical Details :

Tenoning Machines & Spindle Moulder Machines

Application :

These very popular design cutters are useful in Window shutters. Yash cutters spell a different class in itself. The finish of the wood and cutter life works in your advantage. The cutters can achieve simple or complex profiling.

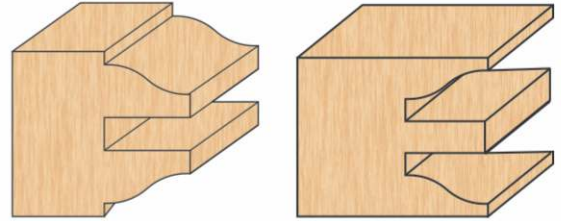

YTB 24-A

ORDER CODE	DIA	WOOD THICKNESS	BORE			TEETH
YTB 24 A 101	125	32 to 40	30	31.75	35	4
YTB 24 A 102	125	32 to 40	30	31.75	35	4
YTB 24 A 103	125	32 to 40	30	31.75	35	4
YTB 24 A 104	125	32 to 40	30	31.75	35	4
YTB 24 A 105	125	32 to 40	30	31.75	35	4
YTB 24 A 106	125	32 to 40	30	31.75	35	4

2 PCS. Cutter Set

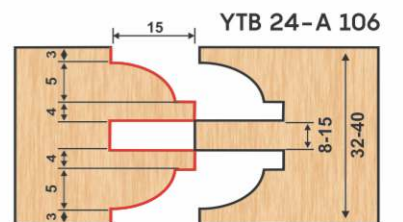
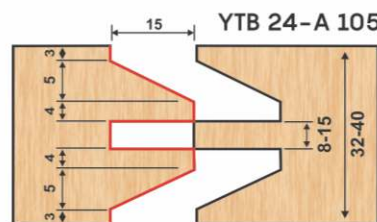
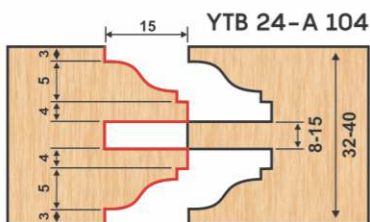
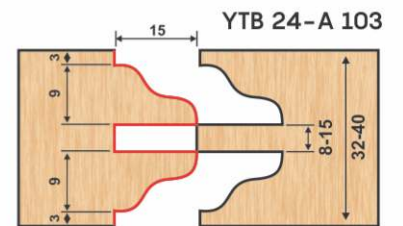
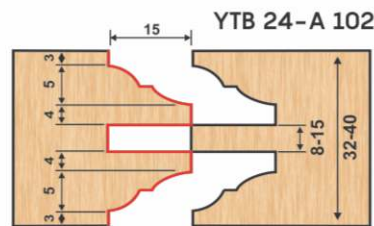
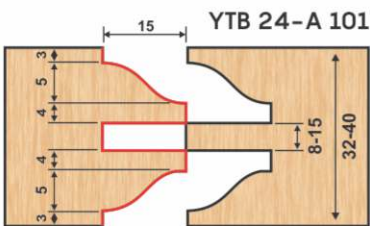
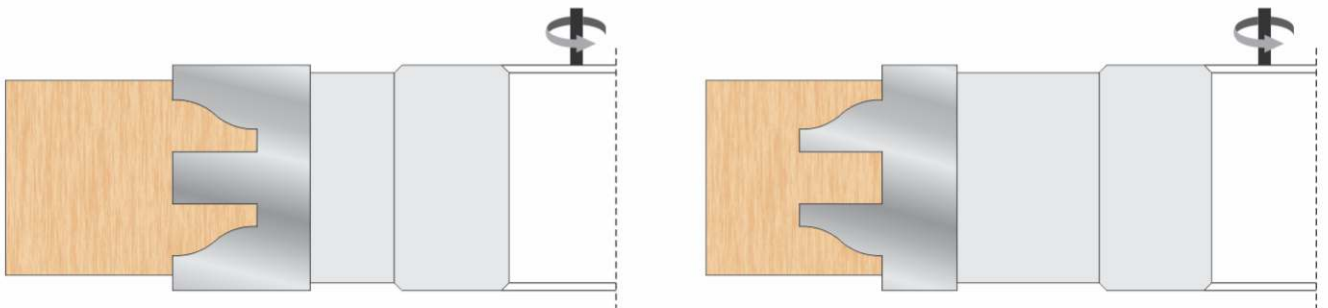

Cutter Head Set For Door Frame T.C.T (Brazed) - YTB 25 (8 Pcs Set)

Technical Details :

Use on Spindle Molder Machines, Double-end Tenoners and Shapers Machines

Application :

High Quality Carbide Tip For Long Life & Many Re — sharpening , Precision Ground , 4/6 Wing Cutters For Ultimate



YTB 25

ORDER CODE	DIA	MOULDING SIZE	BORE
YTB 25 101	180 / 115	63 to 100	40
YTB 25 102	195 / 115	63 to 127	40
YTB 25 103	230 / 115	75 to 125	40

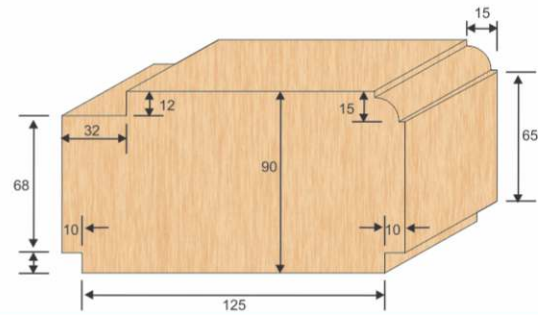

USE ON 4 SIDE MOULER MACHINE

8 PCS. Cutter Set

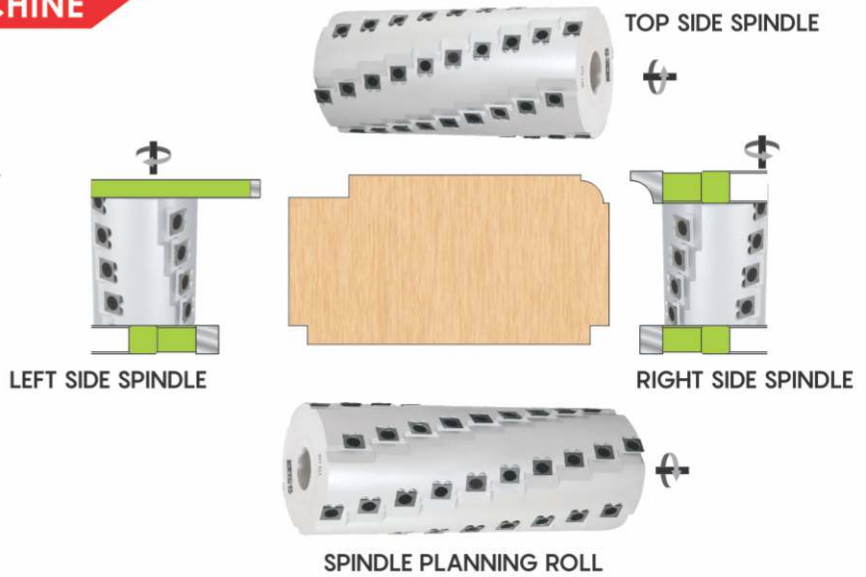
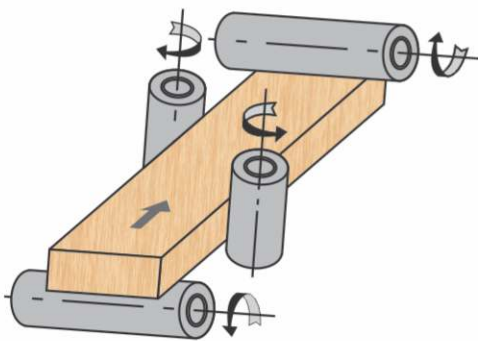

YTB 25 101

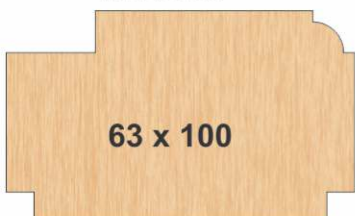

YTB 25 102



YTB 25 103

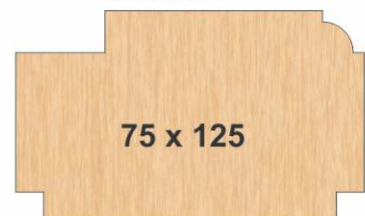

Cutter Head Set For Adjustable Tongue & Groove Cutter T.C.T (Brazed) - YTB 26

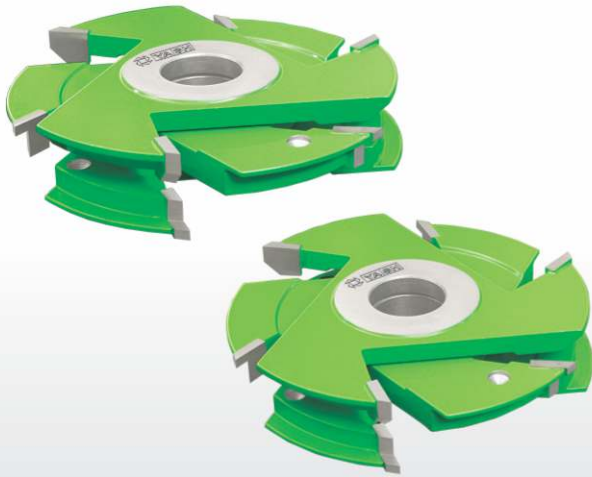

ADJUSTABLE

Technical Details :

Spindle Moulder Machines & Four Side Moulder Machines

Application :

High Quality Carbide Tip For Long Life & Many Re - sharpening , Precision Ground , 4/6 Wing Cutters For Ultimate

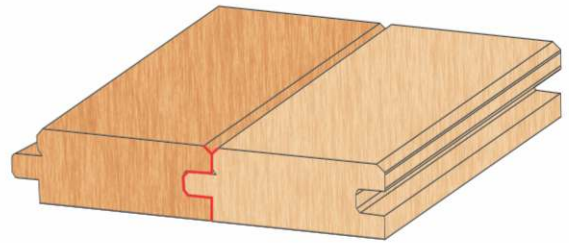

6 PCS. Cutter Set

YTB 26

ORDER CODE	DIA	MOULDING SIZE	BORE	TEETH	
YTB 26 101	150	10 to 18	40	3 + 3	6 Pcs Set
YTB 26 102	150	10 to 18	40	4 + 4	6 Pcs Set

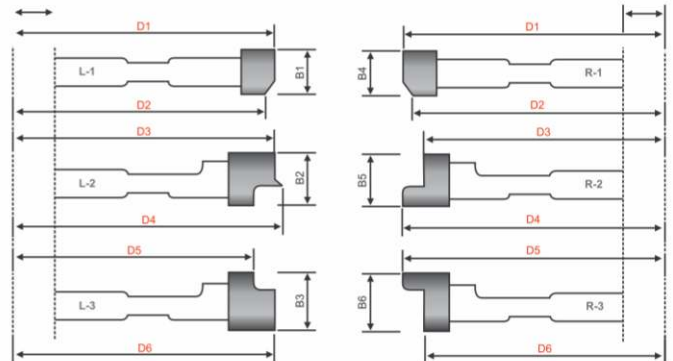
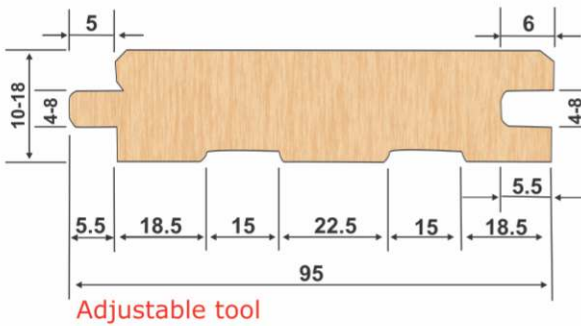

YTB 26

ORDER CODE	DIA	THICKNESS	BORE	TEETH	
YTB 26 103	125	16mm	40	4	3 Pcs Set

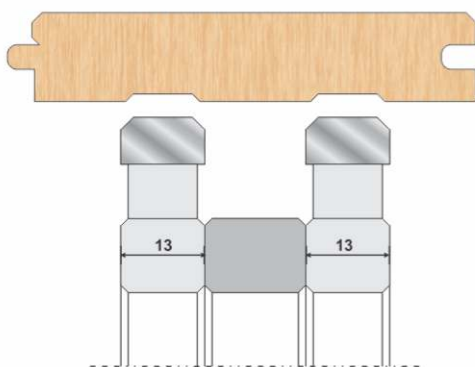

YTB 26

ORDER CODE	DIA	MOULDING SIZE	BORE	TEETH
YTB 26 104	125	95mm	40	4
YTB 26 105	125	110mm	40	4

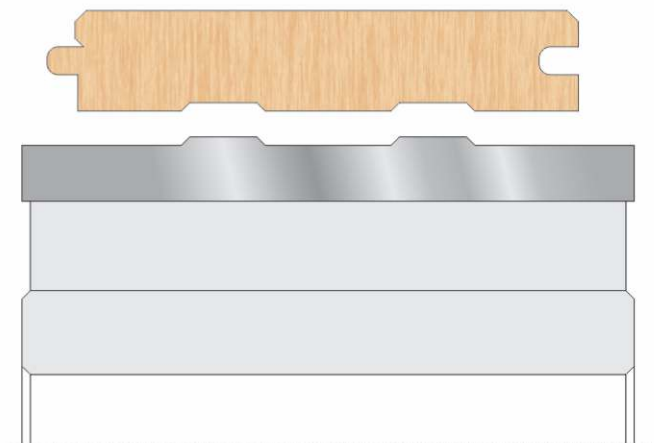

Cutter Head Set For Flooring T.C.T (Brazed) - YTB 27 (9 pcs Set)

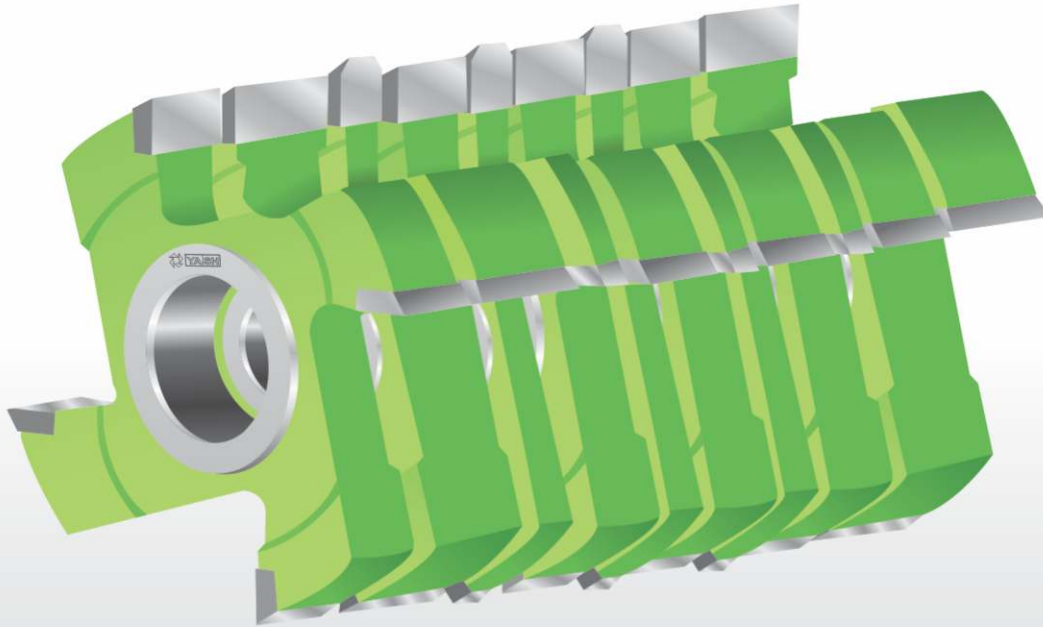

YTB 27				
ORDER CODE	DIA	MOULDING SIZE	BORE	TEETH
YTB 27 101	125	60 to 125	40	4

Technical Details :
Spindle Moulder Machines & Four Side Moulder Machines

Application :
This Set Contains 9 Pcs for Flooring Back Grooving With Planning In Wood The Cutter Set Allow The Insetion Of Cutter According To Wood Width 60 mm To 125 mm

According To Wood Thickness Use Below Mention Numbers Cutters

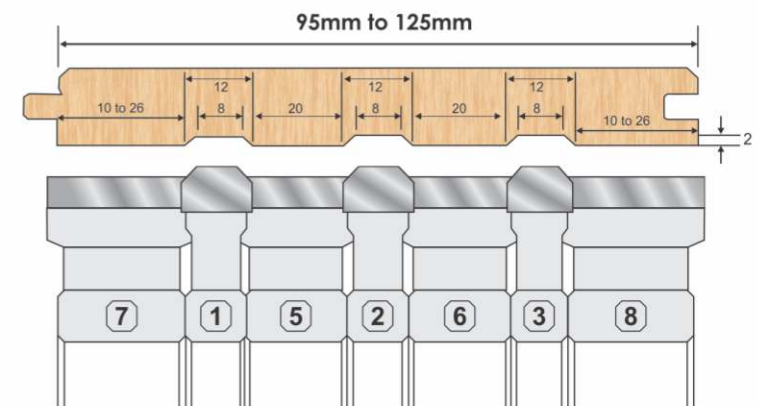
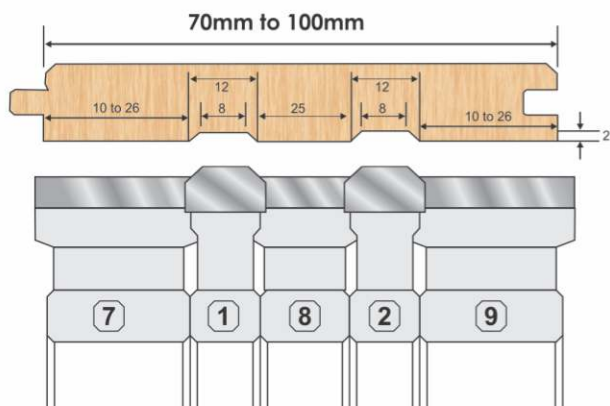
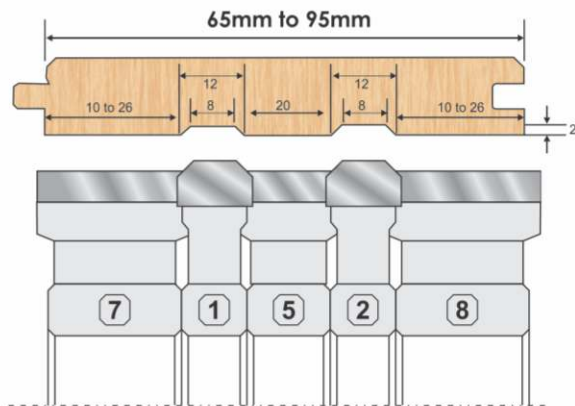
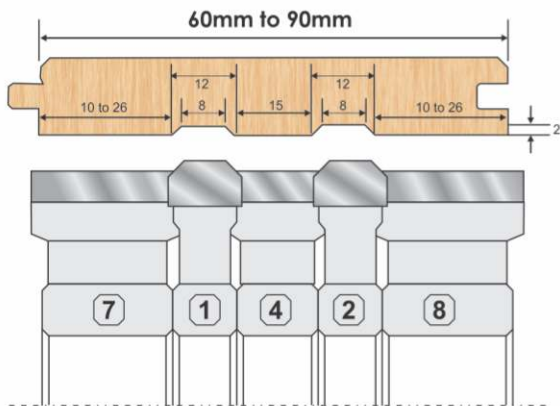

Cutter Head Set For Adjustable Tounge & Groove Cutter T.C.T (Brazed) - YTB 28(4 pcs Set)

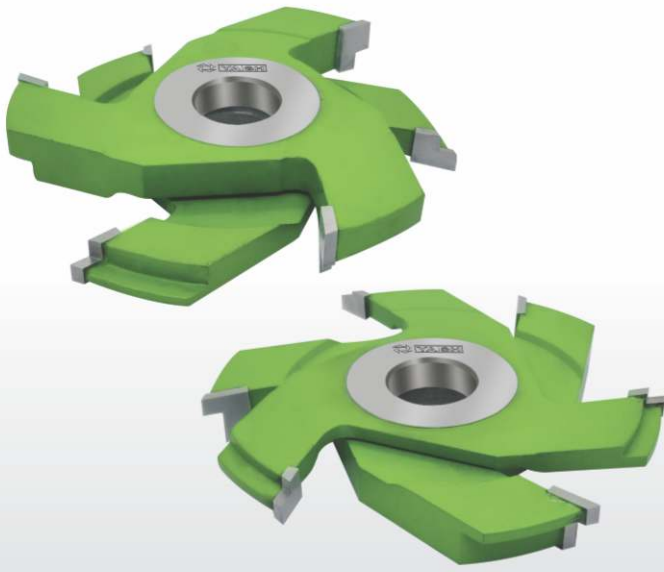

Technical Details :

Spindle Moulder Machines & Four Side Moulder Machines

Application :

Perfect For Solid Wood & Panel Materials From 10 mm wood To 18 mm Wood

YTB 28

ORDER CODE	DIA	MOULDING SIZE	BORE	TEETH
YTB 28 101	150	10 to 18	40	3 + 3
YTB 28 102	150	10 to 18	40	4 + 4

4 PCS. Cutter Set

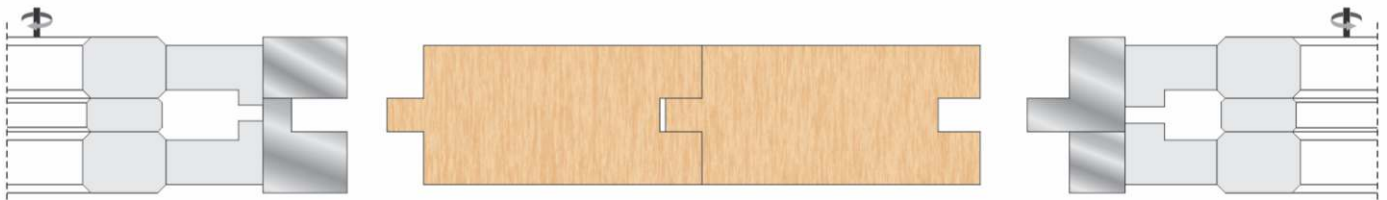

Cutter Head Set For Locking & Flooring T.C.T (Brazed) - YTB 29

YTB 29

ORDER CODE	DIA	MOULDING SIZE	BORE	TEETH
YTB 29 101	125	14mm	40	4
YTB 29 102	125	19mm	40	4

Technical Details :

Spindle Moulder Machines & Four Side Moulder Machines

Application :

Perfect For Solid Wood & Panel Materials From 14 mm wood To 19 mm Wood

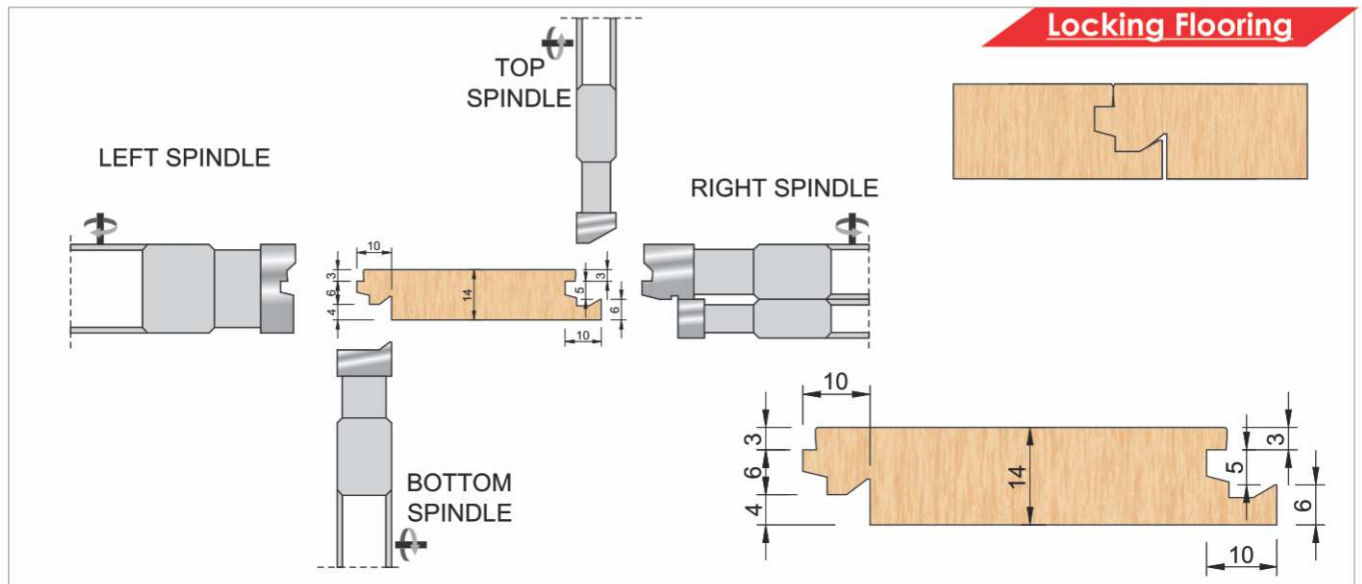

Cutter Head Set For Flooring T.C.T (Brazed) - YTB 30

ROTATE | MAC | MAN

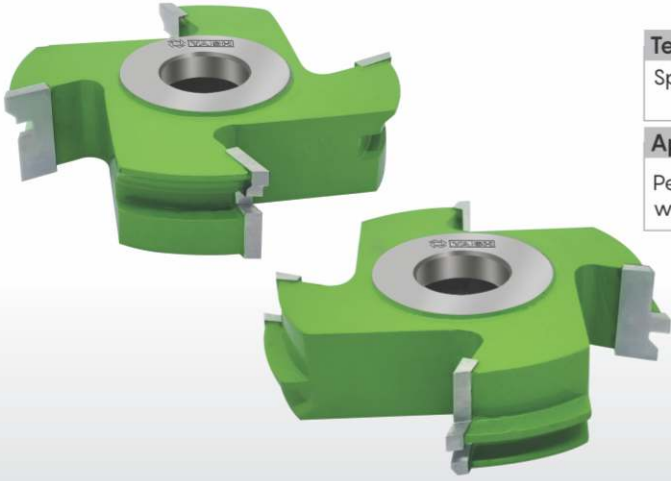

Technical Details :

Spindle Moulder Machines & Four Side Moulder Machines

Application :

Perfect For Solid Wood & Panel Materials From 14 mm wood To 20 mm Wood

YTB 30

ORDER CODE	DIA	WOOD THICKNESS	BORE		TEETH
YTB 30 101	125	14 to 20	30	31.75	40
YTB 30 102	125	14 to 20	30	31.75	40
YTB 30 103	125	14 to 20	30	31.75	40
YTB 30 104	125	14 to 20	30	31.75	40

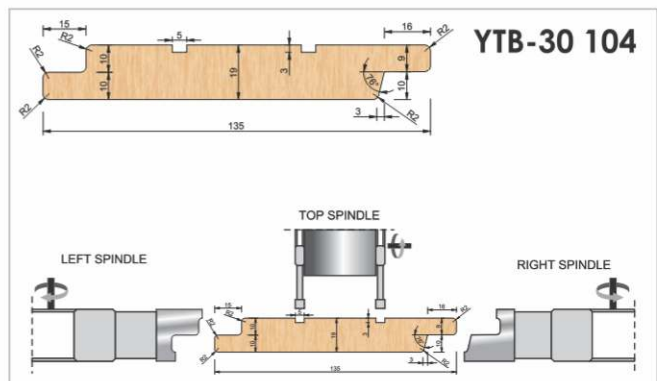
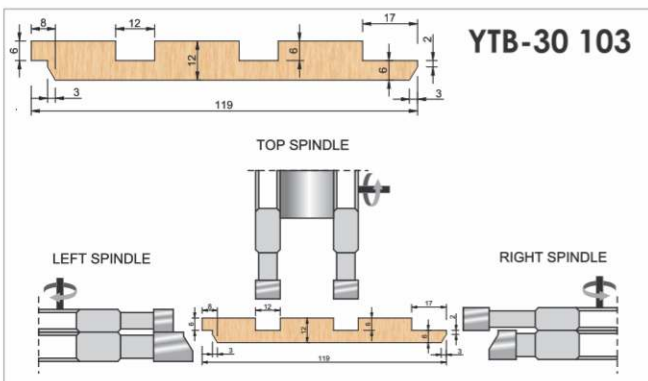
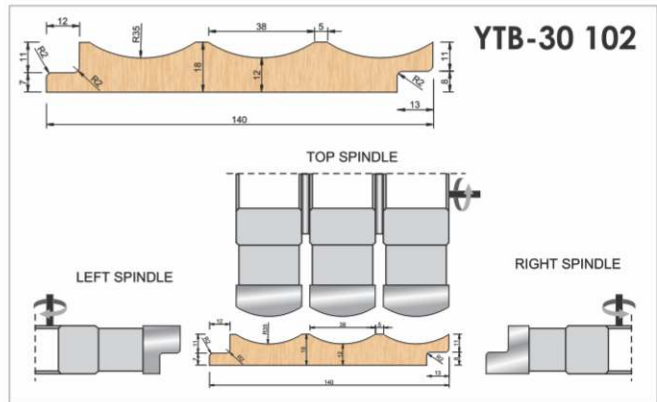
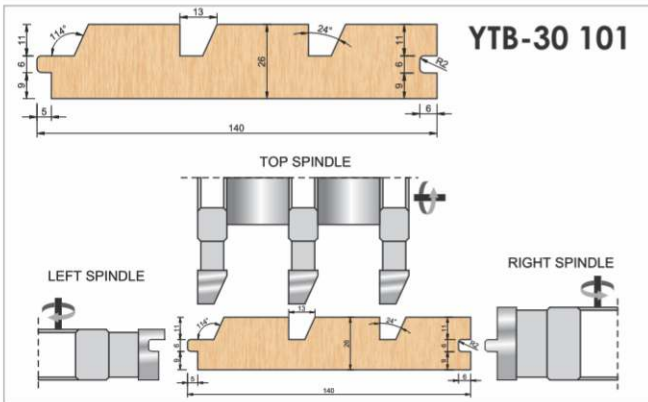
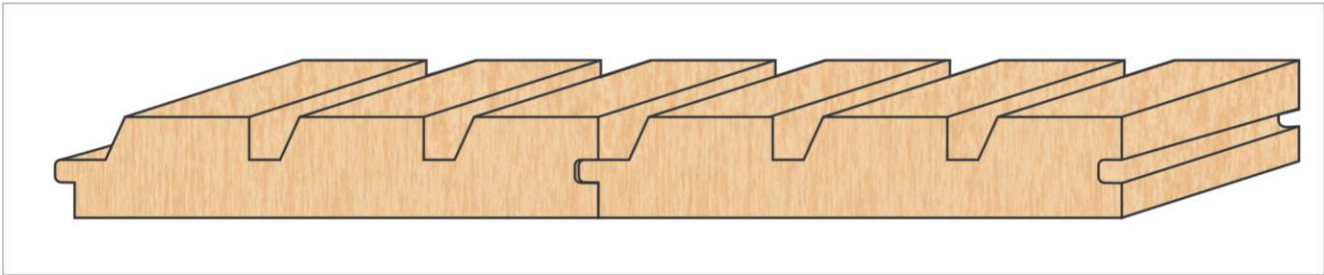

Cutter Head Set For Flooring Fix T.C.T (Brazed) - YTB 31 (2 Pcs Set)

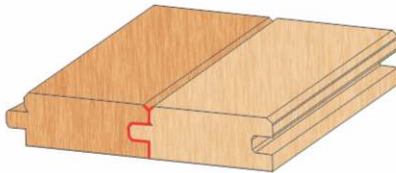

Technical Details :

Spindle Moulder Machines & Four Side Moulder Machines

Application :

Perfect For Solid Wood & Panel Materials From 18 mm wood To 25 mm Wood

YTB 31

ORDER CODE	DIA	WOOD THICKNESS	BORE		TEETH	
YTB 31 101	125	18 to 25	30	31.75	40	4
YTB 31 102	125	18 to 25	30	31.75	40	4
YTB 31 103	125	18 to 25	30	31.75	40	4
YTB 31 104	125	14 to 20	30	31.75	40	4

2 PCS. Cutter Set

YTB-31 101

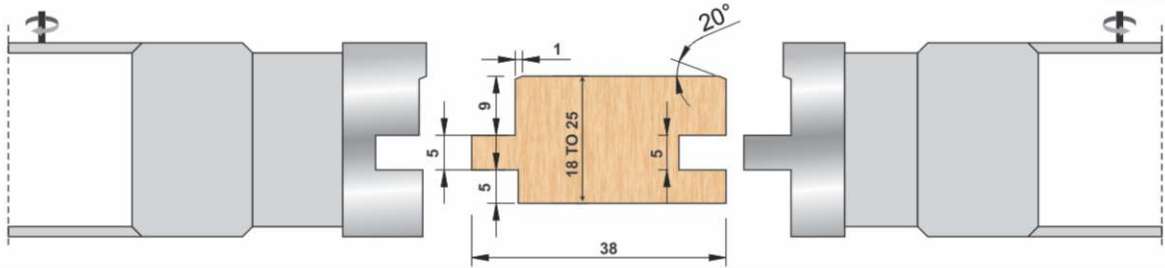

2 PCS. Cutter Set

YTB-31 102

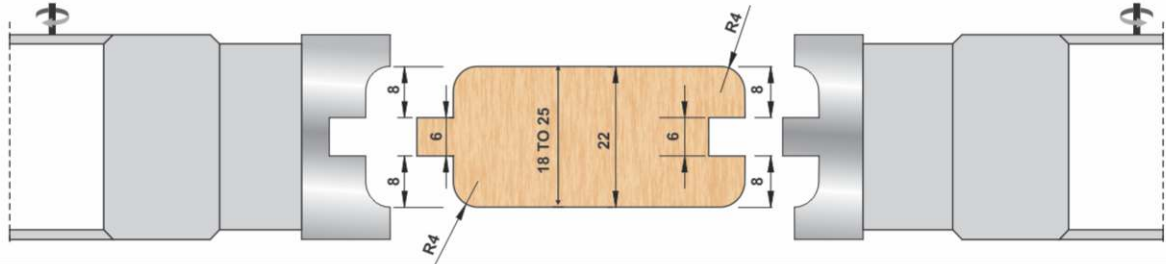

2 PCS. Cutter Set

YTB-31 103

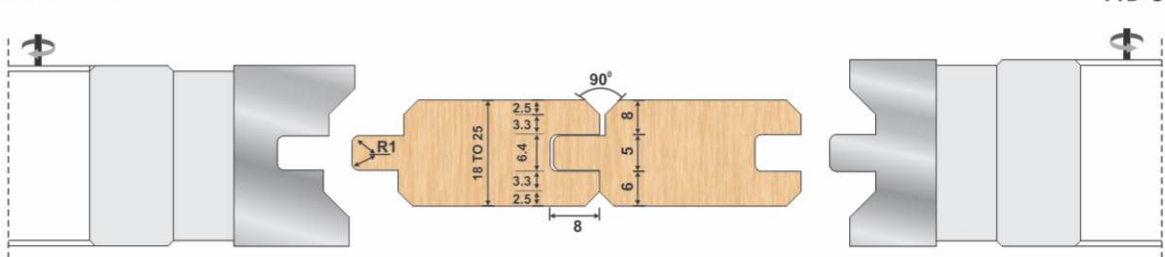

2 PCS. Cutter Set

YTB-31 104

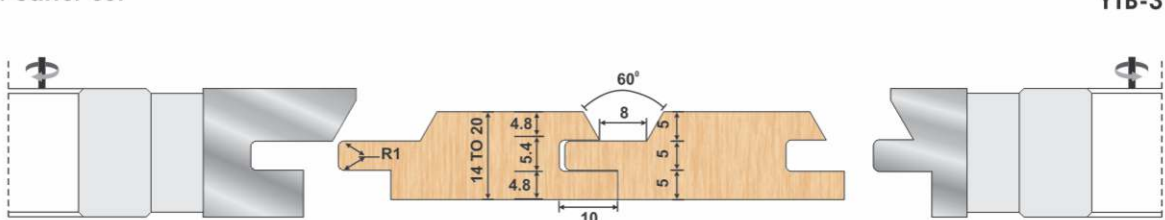

Cutter Head Set For Tongue & Groove Fix T.C.T (Brazed) - YTB 32 (2 Pcs Set)

ROTATE | MAC | MAN

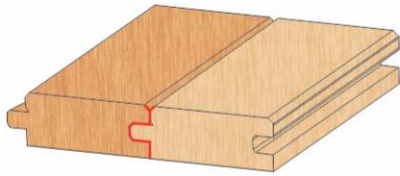
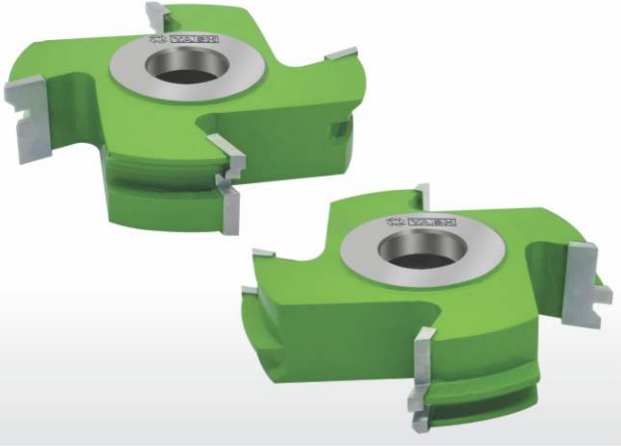

Technical Details :
Spindle Moulder Machines & Four Side Moulder Machines

Application :
Perfect For Solid Wood & Panel Materials From 18 mm wood To 25 mm Wood

YTB 32						
ORDER CODE	DIA	WOOD THICKNESS	BORE		TEETH	
YTB 32 101	125	18 to 25	30	31.75	40	4
YTB 32 102	125	16 to 25	30	31.75	40	4
YTB 32 103	125	16 to 25	30	31.75	40	4
YTB 32 104	125	16 to 25	30	31.75	40	4
YTB 32 105	125	16 to 25	30	31.75	40	4

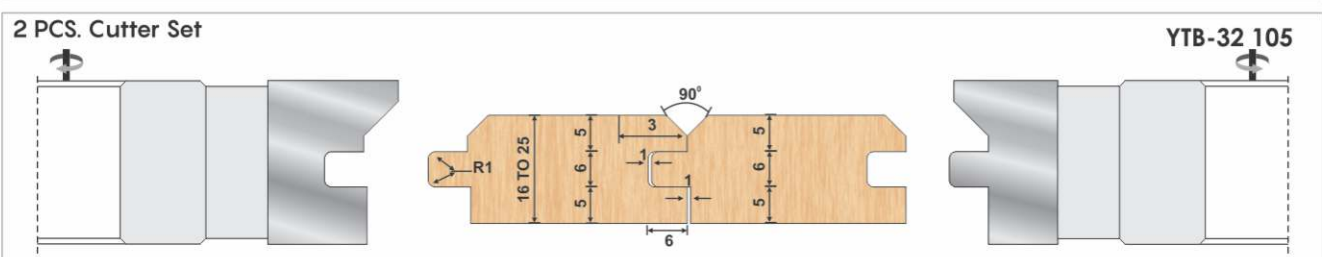
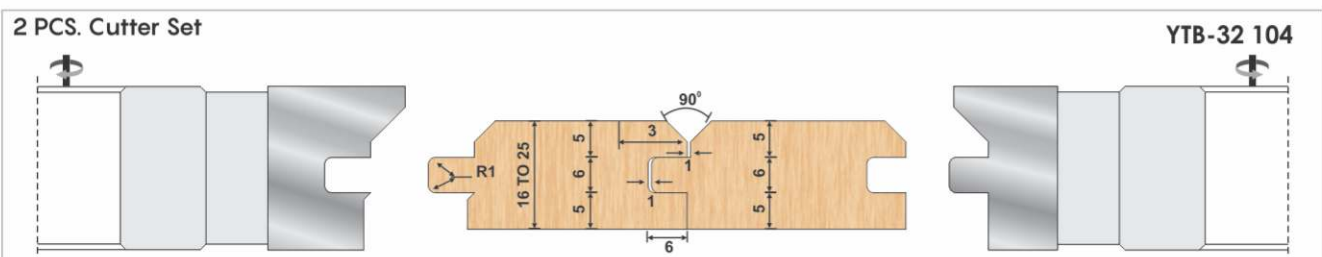
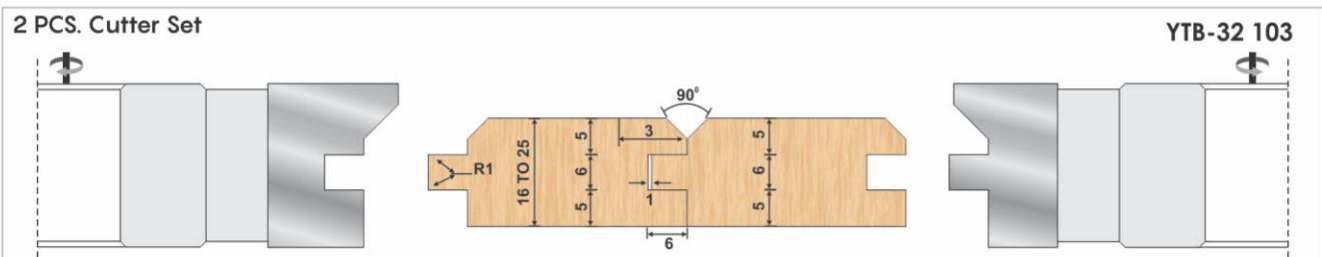
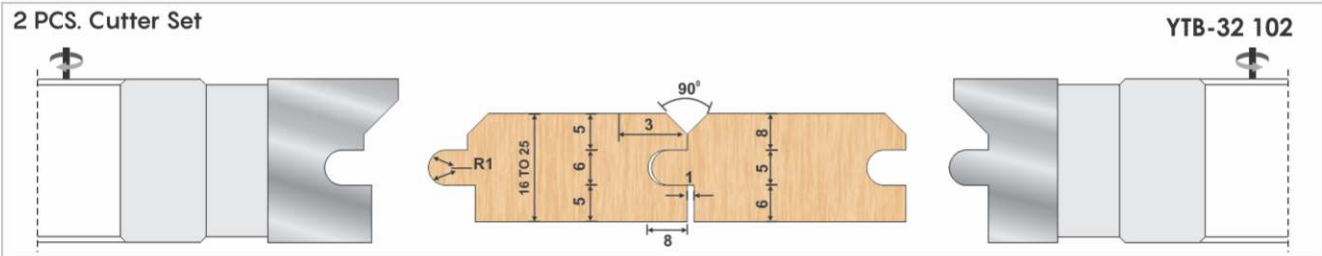
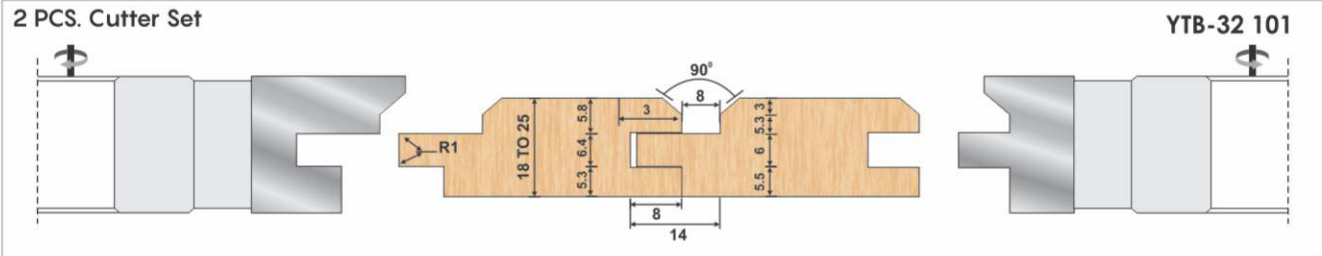

Cutter Head Set For Tongue & Groove Fix T.C.T (Brazed) - YTB 33 (2 Pcs Set)

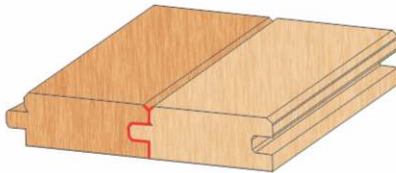
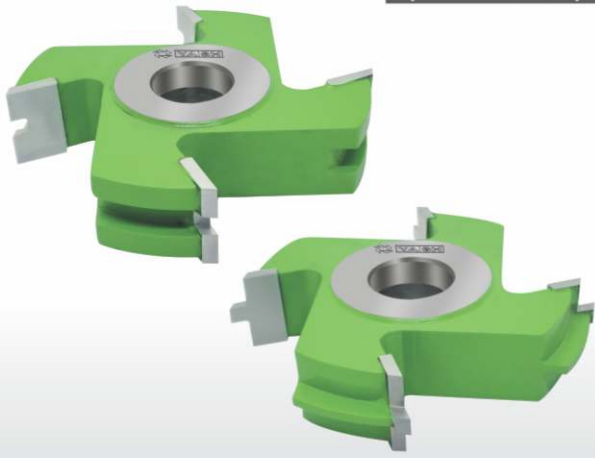

Technical Details :

Spindle Moulder Machines & Four Side Moulder Machines

Application :

Perfect For Solid Wood & Panel Materials From 18 mm wood To 25 mm Wood

YTB 33

ORDER CODE	DIA	WOOD THICKNESS	BORE		TEETH
YTB 33 101	125	18 to 25	30	31.75	40
YTB 33 102	125	18 to 25	30	31.75	40
YTB 33 103	125	18 to 25	30	31.75	40
YTB 33 104	125	18 to 25	30	31.75	40

2 PCS. Cutter Set

YTB-33 101

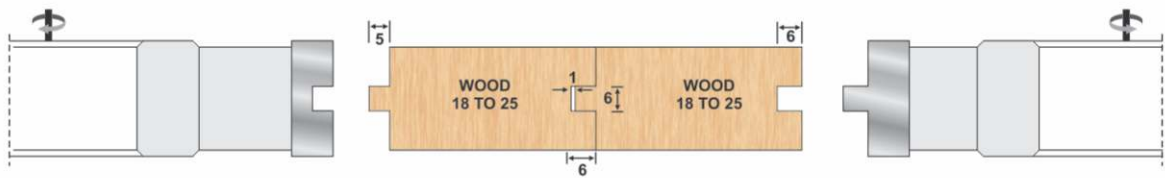

2 PCS. Cutter Set

YTB-33 102

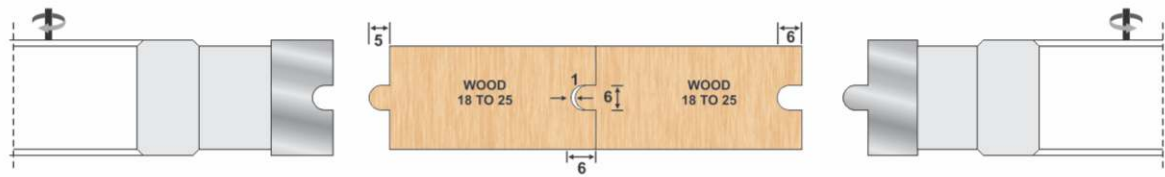

2 PCS. Cutter Set

YTB-33 103

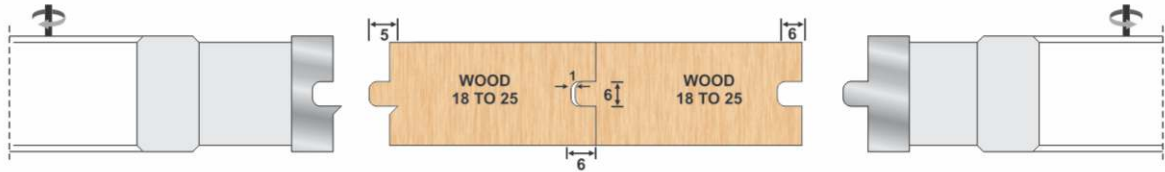

2 PCS. Cutter Set

YTB-33 104

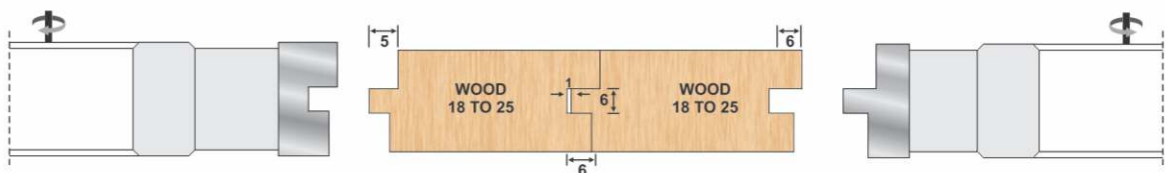

Cutter Head Set For Tounge & Groove Fix T.C.T (Brazed) - YTB 34 (2 Pcs Set)

ROTATE |
 MAC |
 MAN

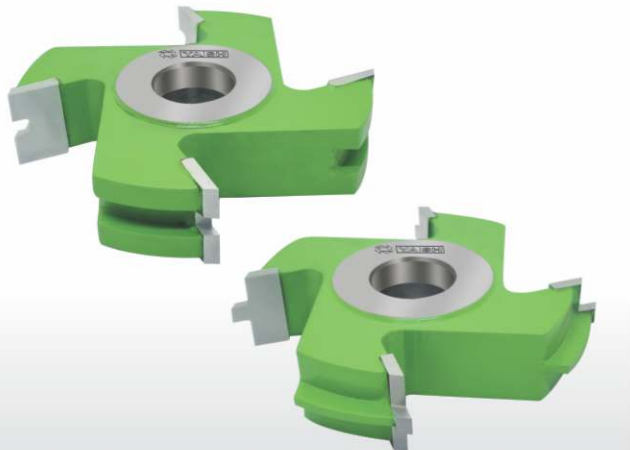

Technical Details :
Spindle Moulder Machines & Four Side Moulder Machines

Application :
Perfect For Solid Wood & Panel Materials From 12 mm wood To 25 mm Wood

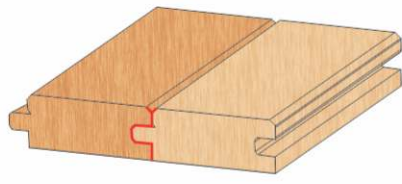

YTB 34						
ORDER CODE	DIA	WOOD THICKNESS	BORE		TEETH	
YTB 34 101	125	12 to 16	30	31.75	40	4
YTB 34 102	125	18 to 25	30	31.75	40	4
YTB 34 103	125	15 to 25	30	31.75	40	4
YTB 34 104	125	15 to 25	30	31.75	40	4

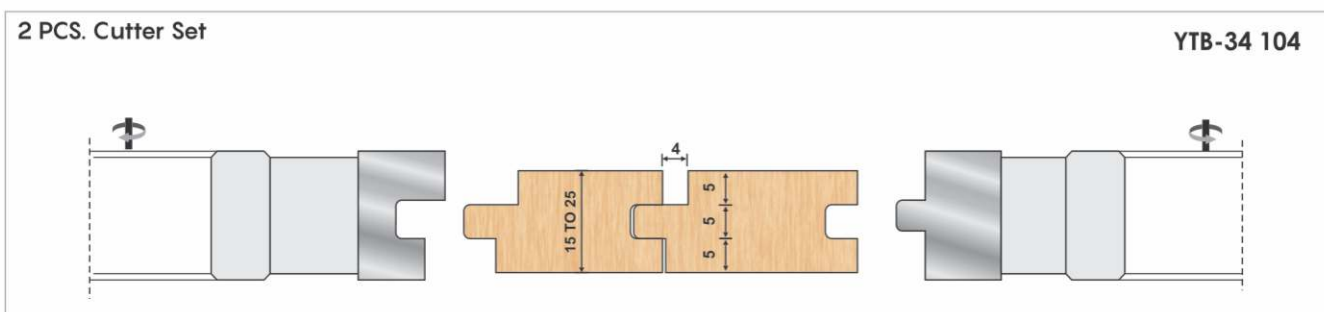
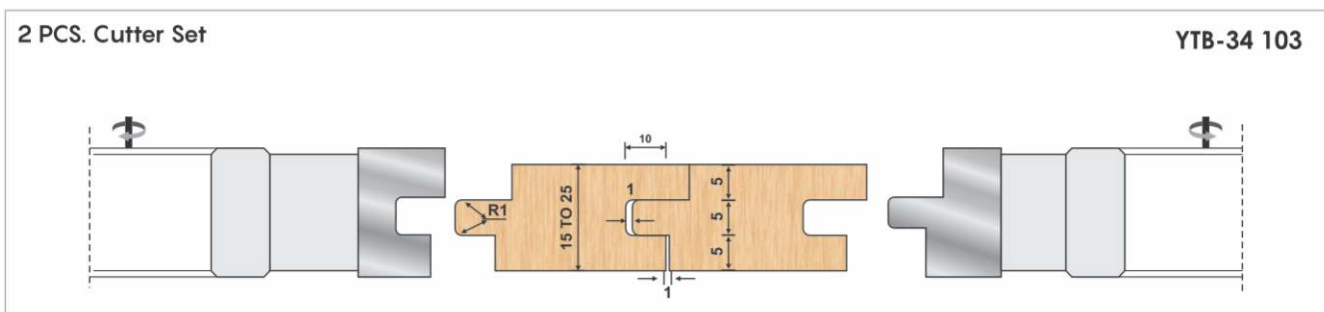
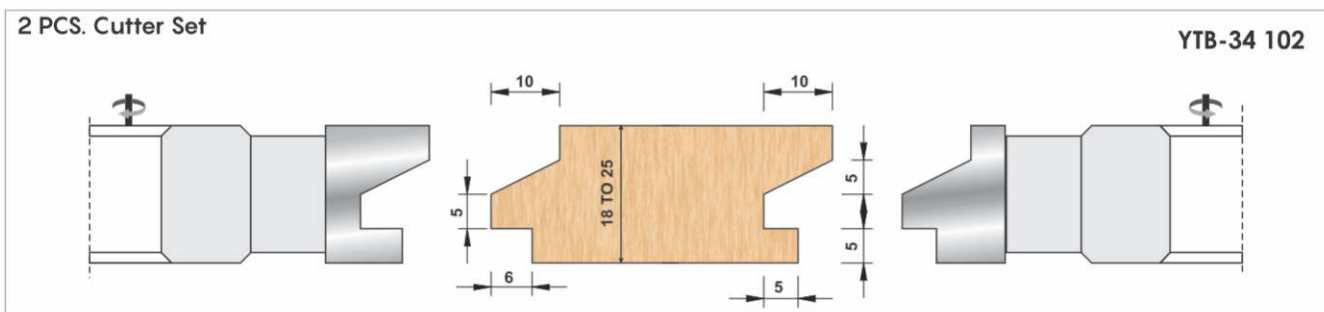
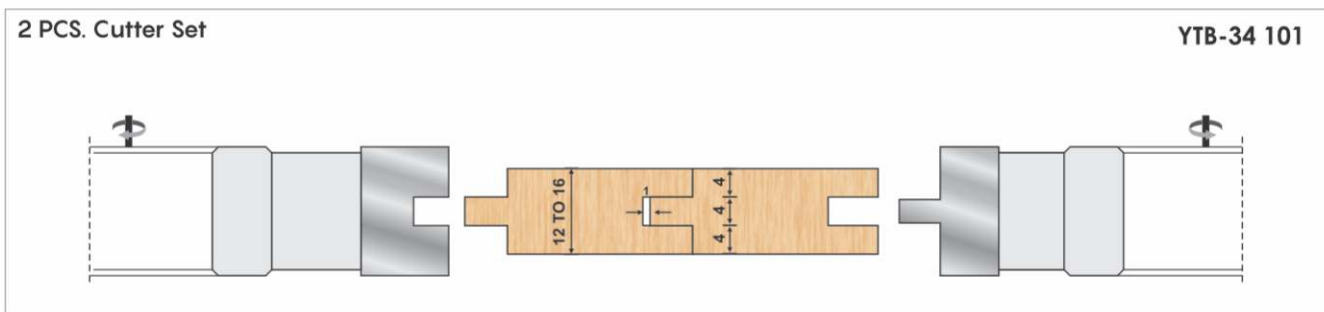

Cutter Head Set For Tounge & Groove T.C.T (Brazed) - YTB 35 (4 Pcs Set)



Technical Details :

Spindle Moulder Machines & Four Side Moulder Machines

Application :

Perfect For Solid Wood & Panel Materials From 18 mm wood To 25 mm Wood

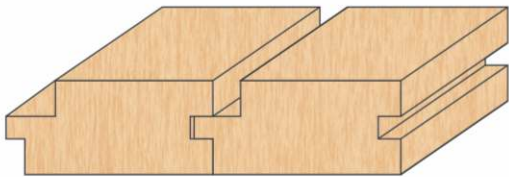

YTB 35

ORDER CODE	DIA	WOOD THICKNESS	BORE		TEETH
YTB 35 101	125	18 to 25	30	31.75	40
YTB 35 102	125	18 to 25	30	31.75	40
YTB 35 103	125	18 to 25	30	31.75	40

4 PCS. Cutter Set

YTB-35 101

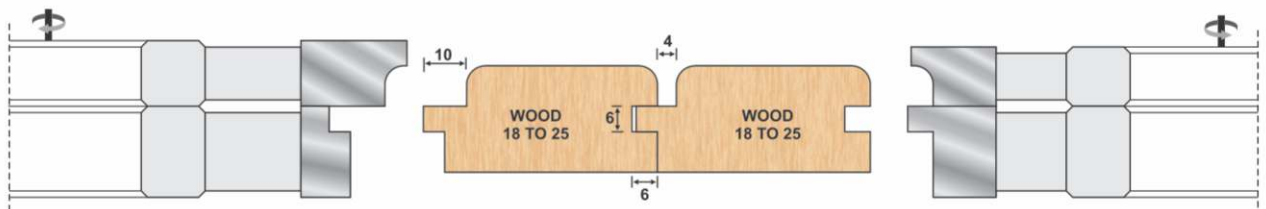

4 PCS. Cutter Set

YTB-35 102

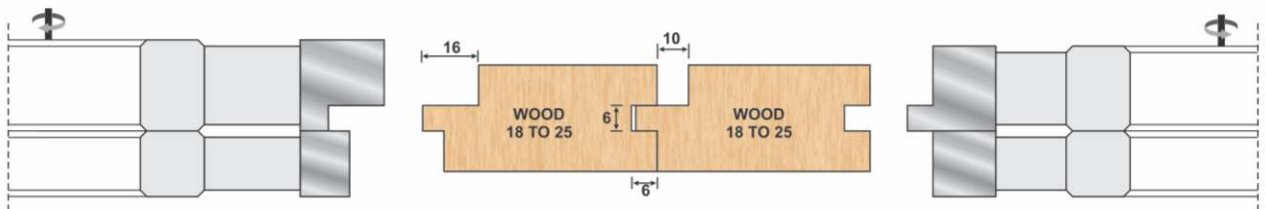

4 PCS. Cutter Set

YTB-35 103

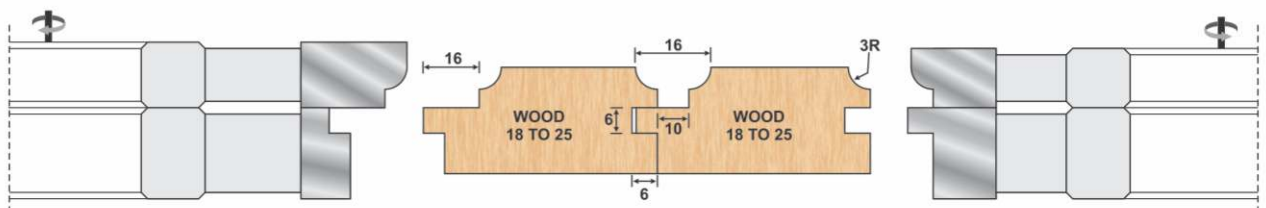

Cutter Head Set For Tounge & Groove T.C.T (Brazed) - YTB 36 (4 Pcs Set)

ROTATE | MAC | MAN

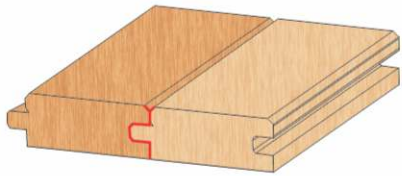
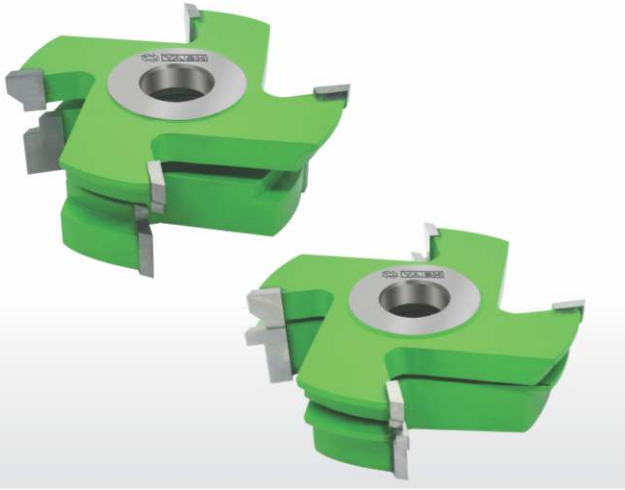

Technical Details :
Spindle Moulder Machines & Four Side Moulder Machines

Application :
Perfect For Solid Wood & Panel Materials From 18 mm wood To 25 mm Wood

YTB 36						
ORDER CODE	DIA	WOOD THICKNESS	BORE		TEETH	
YTB 36 101	125	18 to 25	30	31.75	40	4
YTB 36 102	125	18 to 25	30	31.75	40	4
YTB 36 103	125	18 to 25	30	31.75	40	4
YTB 36 104	125	18 to 25	30	31.75	40	4

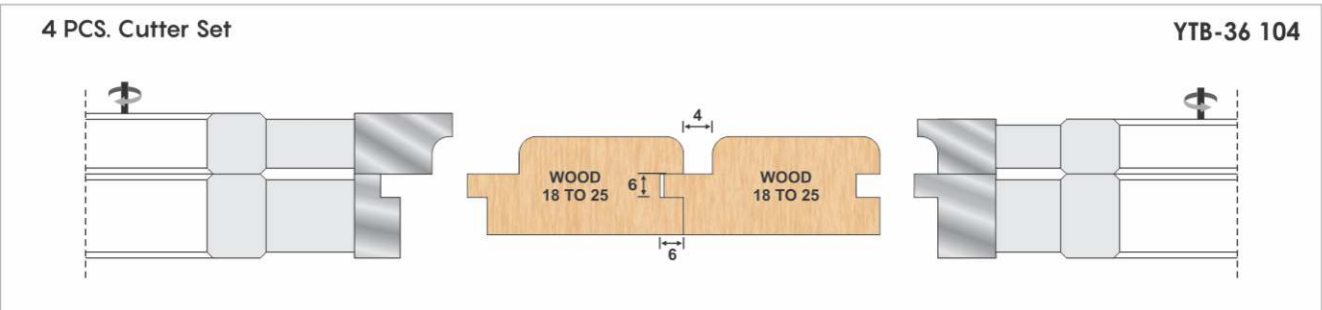
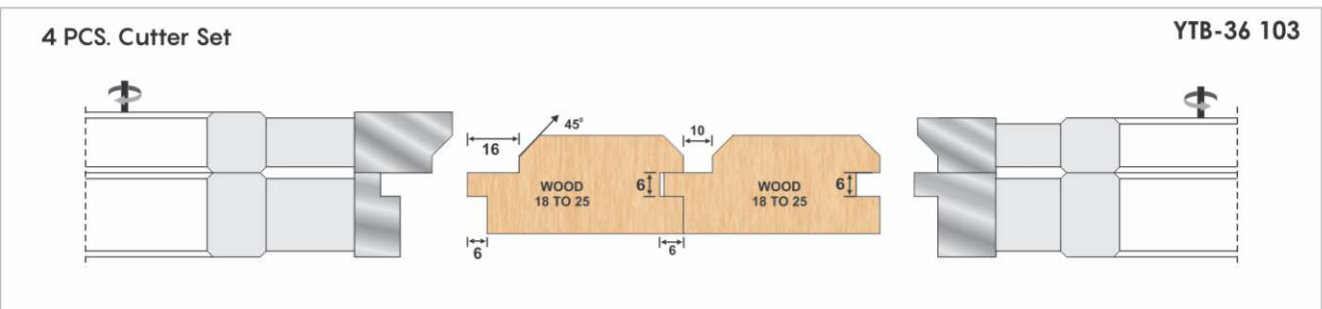
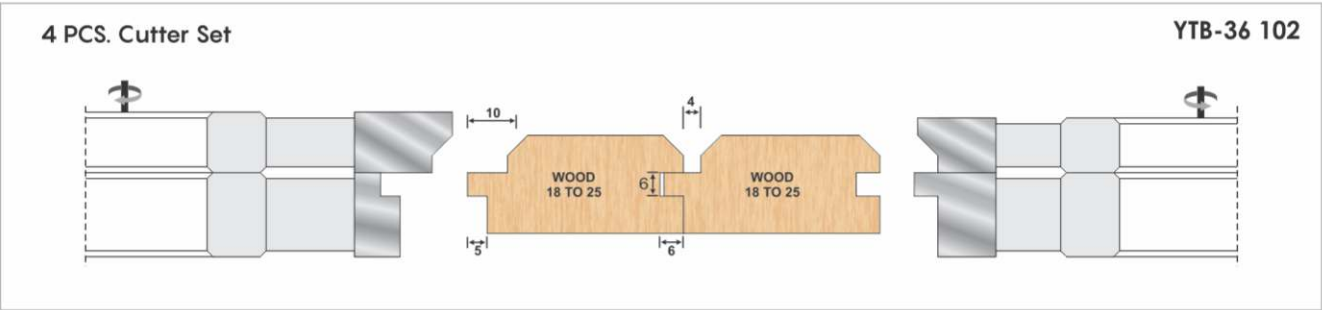
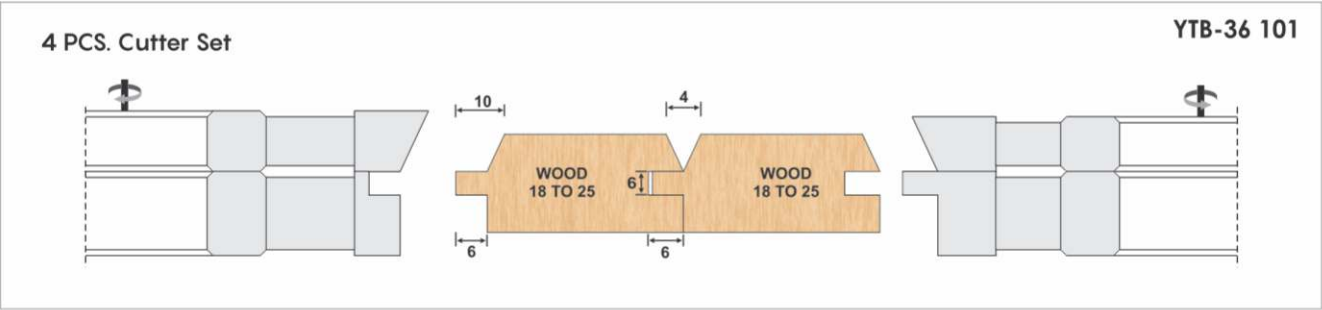

Cutter Head Set For Tounge & Groove One Pices T.C.T (Brazed) - YTB 38

ROTATE | MAC | MAN

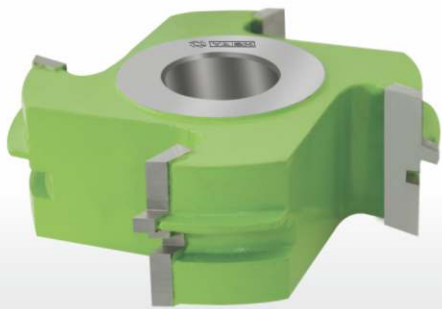

Technical Details :
Spindle Moulder Machines

Application :
Perfect For Solid Wood & Panel Materials
From 16 mm wood To 38 mm Wood

YTB 38						
ORDER CODE	DIA	WOOD THICKNESS	BORE		TEETH	
YTB 38 101	125	16 to 38	30	31.75	35	4
YTB 38 102	125	16 to 38	30	31.75	35	4

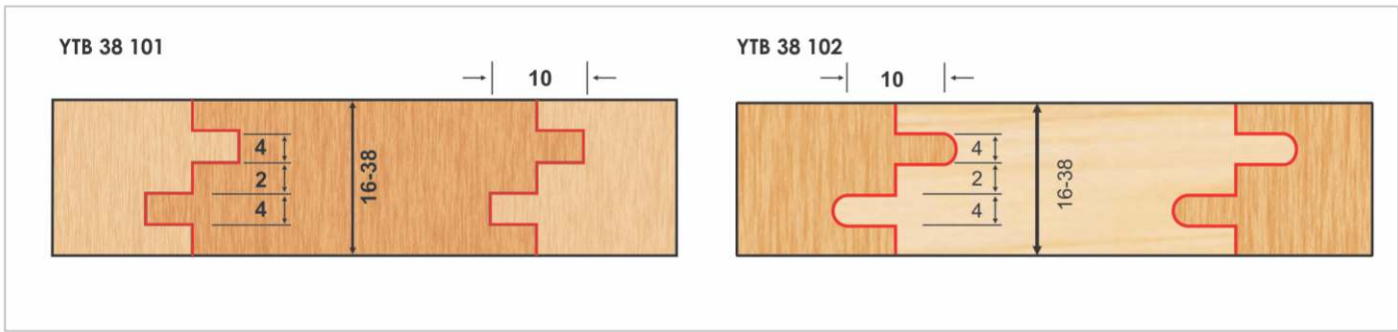

Cutter Head Set For Tounge & Groove One Pices T.C.T (Brazed) - YTB 39

Technical Details :
Use on Spindle Molder Machines, Double-end Tenoners and Shapers Machines

YTB 39						
ORDER CODE	DIA	WOOD THICKNESS	BORE		TEETH	
YTB 39 101	125	30 to 40	30	31.75	35	4

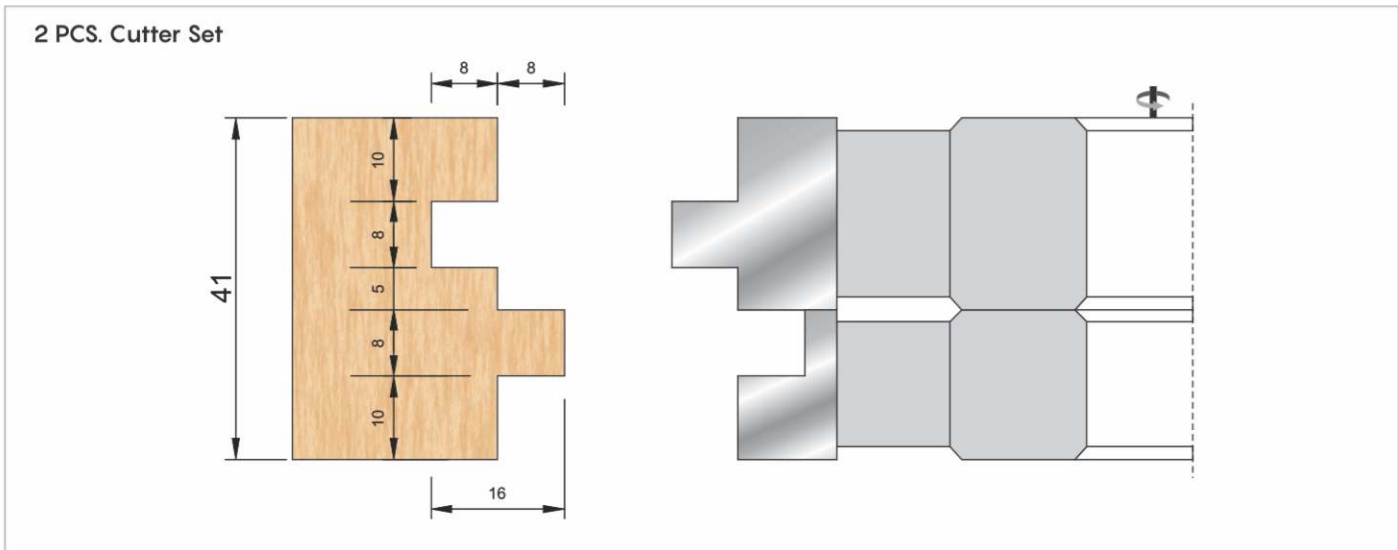

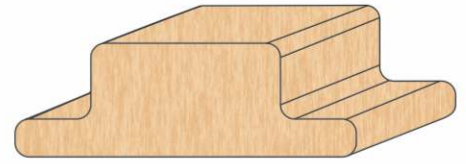
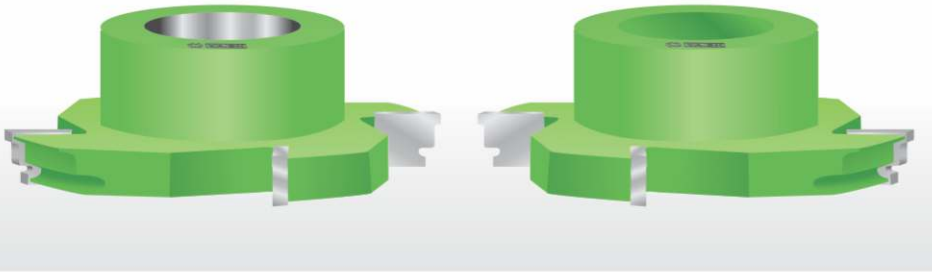

2 PCS. Cutter Set

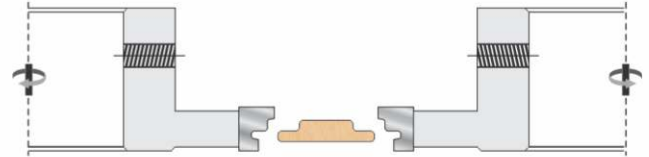
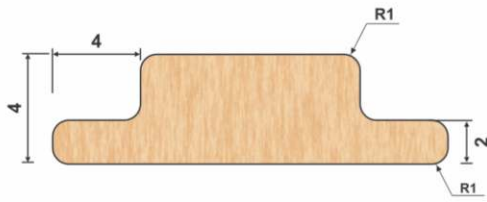

YTB 40

ORDER CODE	DIA	WOOD THICKNESS	BORE	TEETH
YTB 40 101	100	4mm	24	4
YTB 40 102	100	4mm	24	6

2 PCS. Cutter Set

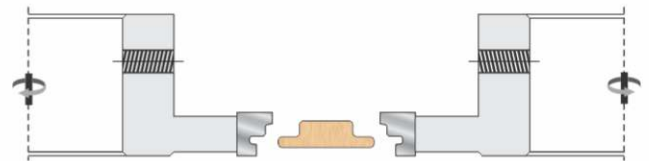
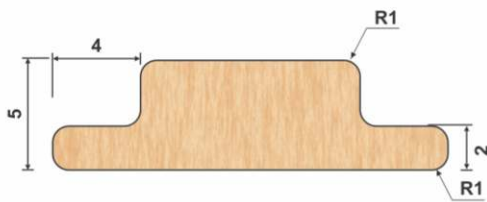

YTB 40

ORDER CODE	DIA	WOOD THICKNESS	BORE	TEETH
YTB 40 103	100	5mm	24	4
YTB 40 104	100	5mm	24	6

2 PCS. Cutter Set

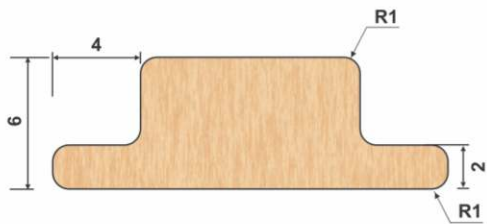

YTB 40

ORDER CODE	DIA	WOOD THICKNESS	BORE	TEETH
YTB 40 105	100	6mm	24	4
YTB 40 106	100	6mm	24	6

2 PCS. Cutter Set

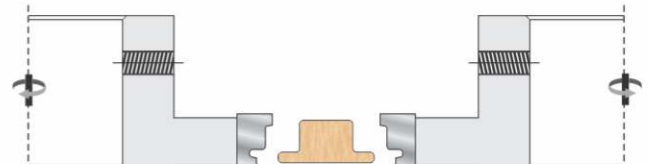
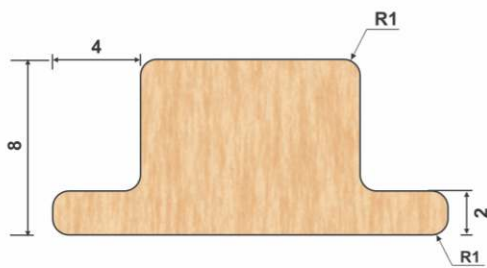

YTB 40

ORDER CODE	DIA	WOOD THICKNESS	BORE	TEETH
YTB 40 107	100	8mm	24	4
YTB 40 108	100	8mm	24	6

EDGE Rounding Cutter T.C.T (Brazed) - YTB 41



YTB 41

ORDER CODE	DIA	WOOD THICKNESS	BORE	TEETH
YTB 41 101	100	3mm / 1.5 R	25.4	6
YTB 41 102	100	4mm / 2 R	25.4	6
YTB 41 103	100	5mm / 2.5 R	25.4	6
YTB 41 104	100	6mm / 3 R	25.4	6
YTB 41 105	100	6mm / 60°	25.4	6
YTB 41 106	100	8mm / 60°	25.4	6



2 PCS. Cutter Set



2 PCS. Cutter Set

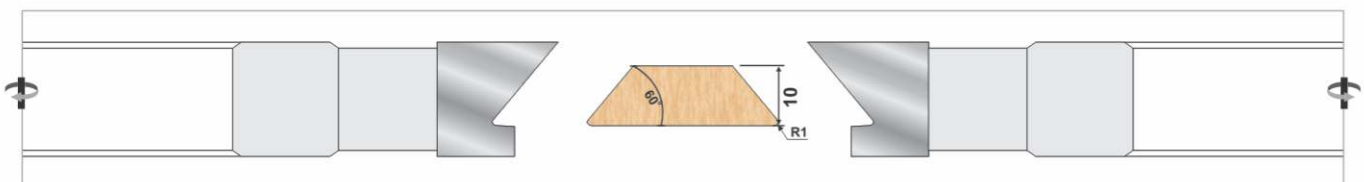
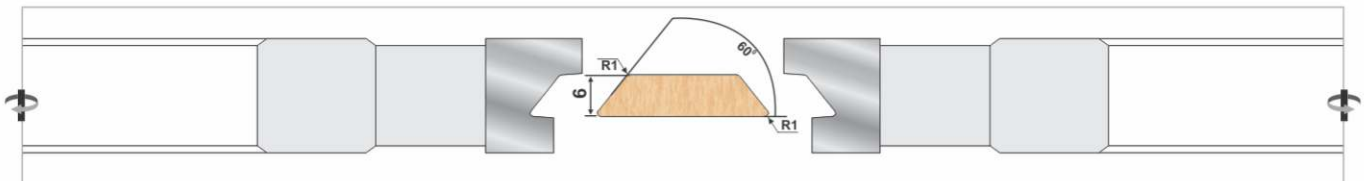

Technical Details :

Spindle Moulder Machines

Application :

Use for wood jointing on edges.

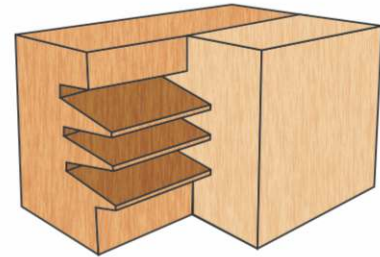
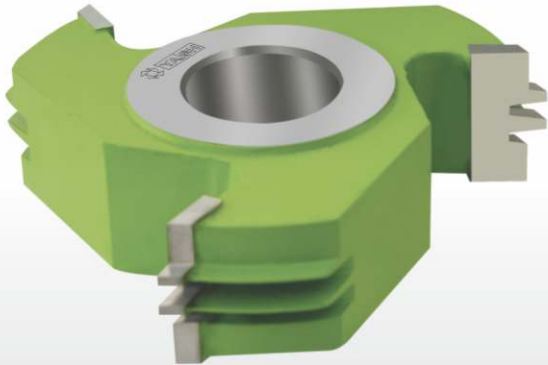

YTB 42

ORDER CODE	DIA	WOOD THICKNESS	BORE			TEETH
YTB 42 101	125	14 to 20	30	31.75	35	3
YTB 42 102	125	14 to 20	30	31.75	35	4

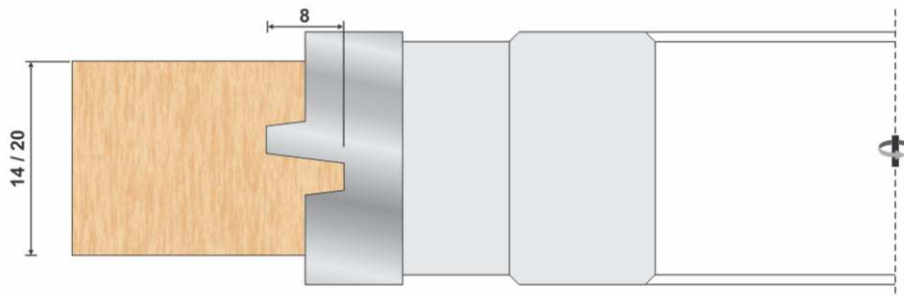

YTB 42

ORDER CODE	DIA	WOOD THICKNESS	BORE			TEETH
YTB 42 103	125	20 to 30	30	31.75	35	3
YTB 42 104	125	20 to 30	30	31.75	35	4

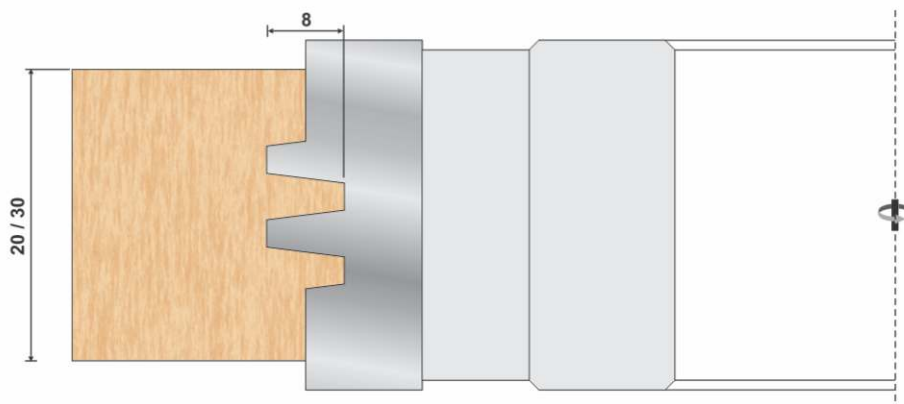

YTB 42

ORDER CODE	DIA	WOOD THICKNESS	BORE			TEETH
YTB 42 105	125	30 to 40	30	31.75	35	3
YTB 42 106	125	30 to 40	30	31.75	35	4

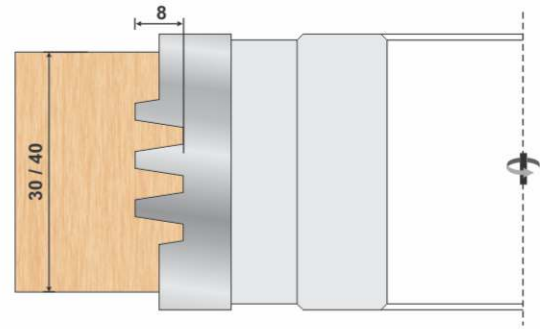

YTB 42

ORDER CODE	DIA	WOOD THICKNESS	BORE			TEETH
YTB 42 107	125	40 to 50	30	31.75	35	3
YTB 42 108	125	40 to 50	30	31.75	35	4

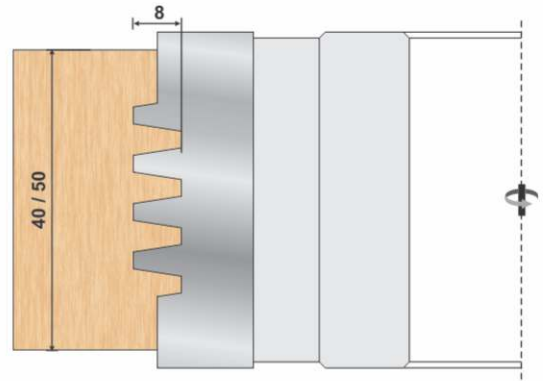

YTB 42

ORDER CODE	DIA	WOOD THICKNESS	BORE			TEETH
YTB 42 109	125	40 to 50	30	31.75	35	3
YTB 42 110	125	40 to 50	30	31.75	35	4

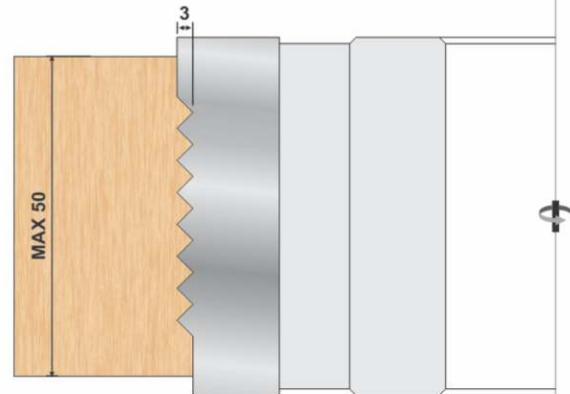

Separate Type Glue Joint Cutter T.C.T (Brazed) - YTB 43

YTB 43

ORDER CODE	DIA	WOOD THICKNESS	BORE			TEETH
YTB 43 101	125	15 to 75	30	31.75	35	4



Separate

use for wood jointing on edges.

Separate Type Glue Joint Cutter Head

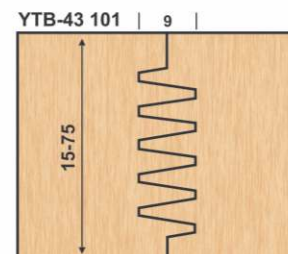

Any Customized Specifications Also Can Make As Per Requirements



YTB 44 101-L
YTB 44 102-R

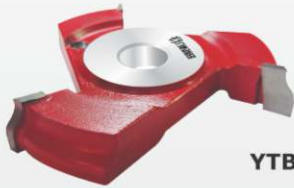

YTB 44 103



YTB 44 104

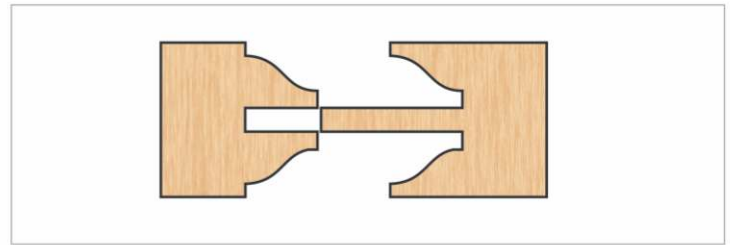

YTB 44

	ORDER CODE	DIA	BORE	WOOD THICKNESS	Z
L	YTB 44 101	125	1"	8.5 x 15/5-S	4
R	YTB 44 102	125	1"	8.5 x 15/5-S	4
	YTB 44 103	125	1"	19 x 15/5-S	3
	YTB 44 104	43	12 SD	15/5-S	2

Chamfer Milling Cutter T.C.T (Brazed) - YTB 45

45 Degree

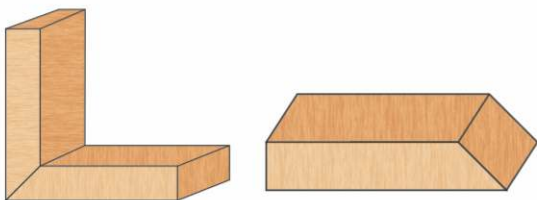

Technical Details :

Spindle Moulder Machines

Application :

For canting off, beveling or chaffering all boards or wood.

YTB 45

WOOD THICKNESS : 15 mm

ORDER CODE	DIA	WOOD THICKNESS	BORE		TEETH
YTB 45 101	125	15 mm	30	31.75	35
YTB 45 102	125	15 mm	30	31.75	35

YTB 45

WOOD THICKNESS : 25 mm

ORDER CODE	DIA	WOOD THICKNESS	BORE		TEETH
YTB 45 103	125	25 mm	30	31.75	35
YTB 45 104	125	25 mm	30	31.75	35

YTB 45

WOOD THICKNESS : 30 mm

ORDER CODE	DIA	WOOD THICKNESS	BORE		TEETH
YTB 45 105	125	30 mm	30	31.75	35
YTB 45 106	125	30 mm	30	31.75	35

YTB 45

WOOD THICKNESS : 40 mm

ORDER CODE	DIA	WOOD THICKNESS	BORE		TEETH
YTB 45 107	125	40 mm	30	31.75	35
YTB 45 108	125	40 mm	30	31.75	35

YTB 45

WOOD THICKNESS : 50 mm

ORDER CODE	DIA	WOOD THICKNESS	BORE		TEETH
YTB 45 109	125	50 mm	30	31.75	35
YTB 45 110	125	50 mm	30	31.75	35

Chamfer Miter Joint Cutter Fix T.C.T (Brazed) - YTB 46

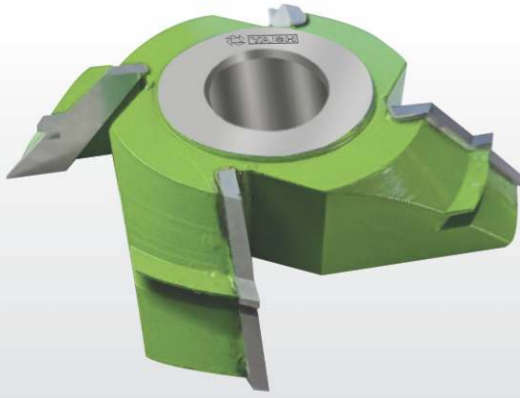

YTB 46

ORDER CODE	DIA	WOOD THICKNESS	BORE			TEETH
YTB 46 101	150	15 to 25	30	31.75	35	3
YTB 46 102	150	15 to 25	30	31.75	35	4

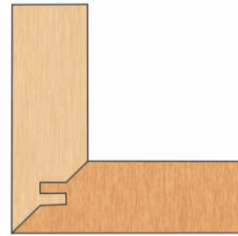

Technical Details :

Spindle Moulder Machines

Chamfer Miter Joint Cutter T.C.T (Brazed) - YTB 47 (2 Pcs Set)

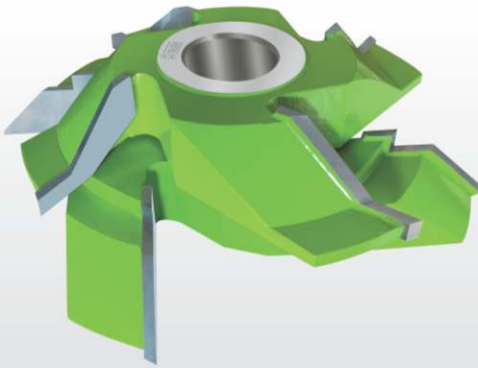

YTB 47

ORDER CODE	DIA	WOOD THICKNESS	BORE			TEETH
YTB 47 101	150	25 to 40	30	31.75	35	3
YTB 47 102	150	25 to 40	30	31.75	35	4
YTB 47 103	150	35 to 50	30	31.75	35	3
YTB 47 104	150	35 to 50	30	31.75	35	4

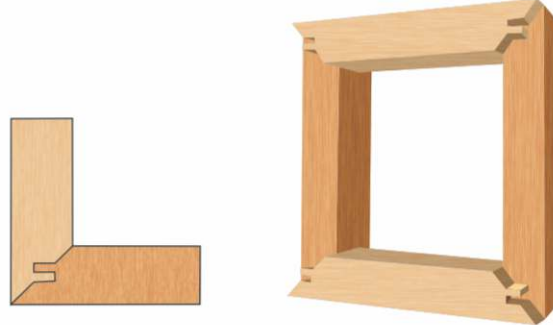

Chamfer Miter Joint Router Bit T.C.T (Brazed) - YTB 48



YTB 48 use for Router Machine

ORDER CODE	DIA	WOOD THICKNESS	SHANK	TEETH
YTB 48 101	75	15 to 25	12 / 16	2
YTB 48 102	75	25 to 40	12 / 16	2
YTB 48 103	75	35 to 50	12 / 16	2

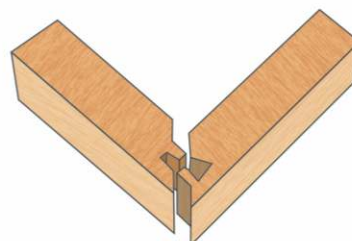

Technical Details :

Use on Router Machine

"V" Groove Cutter T.C.T (Brazed) - YTB 49

Technical Details :

Spindle Moulder Machines & Surface Planner Machine

Application :

Perfect For Solid Wood & Panel Materials, Compressed Wood

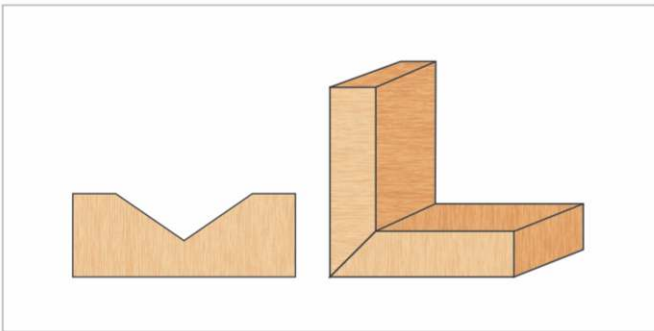
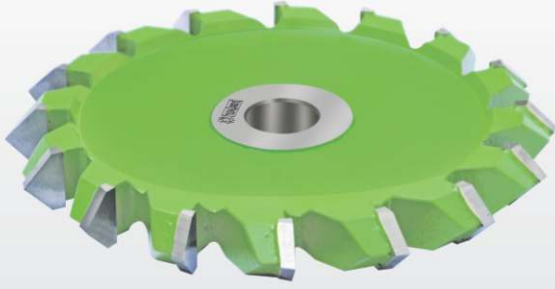

YTB 49

ORDER CODE	DIA	Thickness	BORE		TEETH
YTB 49 101	150	19mm	25.4	30	12
YTB 49 102	150	25mm	25.4	30	12
YTB 49 103	175	19mm	25.4	30	16
YTB 49 104	175	25mm	25.4	30	16
YTB 49 105	200	19mm	25.4	30	16
YTB 49 106	200	25mm	25.4	30	16

Facing Cutter T.C.T (Brazed) - YTB 50

Technical Details :

Use on Finger Joint Machinery

Application :

Perfect For Solid Wood & Panel Materials



YTB 50

ORDER CODE	DIA	THICKNESS	BORE	TEETH
YTB 50 101	125	19 mm	25.4	6
YTB 50 102	150	19 mm	25.4	6

Finger Joint Cutter T.C.T (Brazed) - YTB 51



Technical Details :

Use on Finger Joint Machinery

Application :

Perfect For Solid Wood & Panel Materials



YTB 51

12 PCS. = 1 SET

ORDER CODE	DIA	Thickness	BORE			TEETH
YTB 51 101	125	5 mm	30	31.75	40	4
YTB 51 102	125	7 mm	30	31.75	40	4

Solder For Finger Joint Cutter T.C.T (Brazed) - YTB 52



YTB 52

ORDER CODE	DIA	Thickness	BORE			TEETH
YTB 52 101	125	5 mm	30	31.75	40	4
YTB 52 102	125	7 mm	30	31.75	40	4

Imported Finger Joint Cutter T.C.T (Brazed) - YTB 53



YTB 53

ORDER CODE	DIA	Thickness	BORE			TEETH
YTB 53 101	160	4 / 10 mm	50			2
YTB 53 102	160	4 / 10 mm	70			2

Imported Solder For Finger Joint Cutter T.C.T (Brazed) - YTB 54



YTB 54

ORDER CODE	DIA	Thickness	BORE			TEETH
YTB 54 101	160	4 mm	50			2
YTB 54 102	160	4 mm	70			2

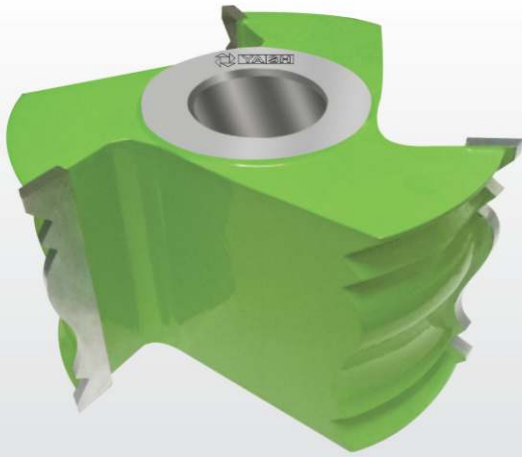

Technical Details :

Spindle Moulder & Four Side Moulder Machines

Application :

Hard Wood & MDF

WOOD THICKNESS :

50mm, 65mm, 75mm, 90mm, 100mm

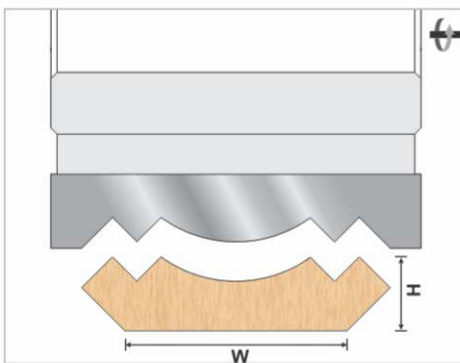

YTB 55 101

YTB 55						
ORDER CODE	DIA	WIDTH	BORE		TEETH	
YTB 55 101 A	125	50mm	30	31.75	35	3 / 4
YTB 55 101 B	125	65mm	30	31.75	35	3 / 4
YTB 55 101 C	125	75mm	30	31.75	35	3 / 4
YTB 55 101 D	125	90mm	30	31.75	35	3 / 4
YTB 55 101 E	125	100mm	30	31.75	35	3 / 4

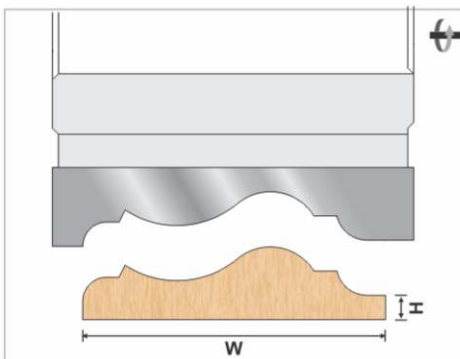

YTB 55 102

YTB 55						
ORDER CODE	DIA	WIDTH	BORE		TEETH	
YTB 55 102 A	125	50mm	30	31.75	35	3 / 4
YTB 55 102 B	125	65mm	30	31.75	35	3 / 4
YTB 55 102 C	125	75mm	30	31.75	35	3 / 4
YTB 55 102 D	125	90mm	30	31.75	35	3 / 4
YTB 55 102 E	125	100mm	30	31.75	35	3 / 4

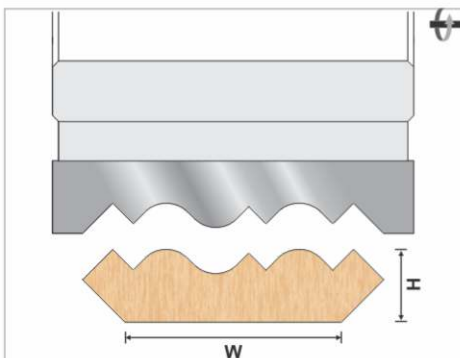

YTB 55 103

YTB 55						
ORDER CODE	DIA	WIDTH	BORE		TEETH	
YTB 55 103 A	125	50mm	30	31.75	35	3 / 4
YTB 55 103 B	125	65mm	30	31.75	35	3 / 4
YTB 55 103 C	125	75mm	30	31.75	35	3 / 4
YTB 55 103 D	125	90mm	30	31.75	35	3 / 4
YTB 55 103 E	125	100mm	30	31.75	35	3 / 4

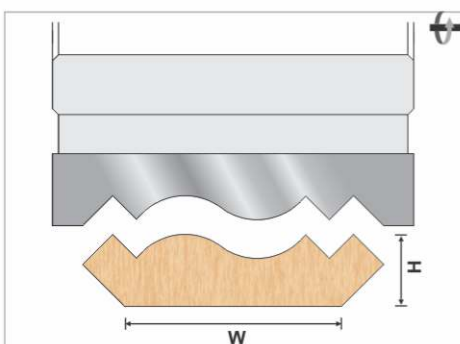

YTB 55 104

YTB 55						
ORDER CODE	DIA	WIDTH	BORE		TEETH	
YTB 55 104 A	125	50mm	30	31.75	35	3 / 4
YTB 55 104 B	125	65mm	30	31.75	35	3 / 4
YTB 55 104 C	125	75mm	30	31.75	35	3 / 4
YTB 55 104 D	125	90mm	30	31.75	35	3 / 4
YTB 55 104 E	125	100mm	30	31.75	35	3 / 4

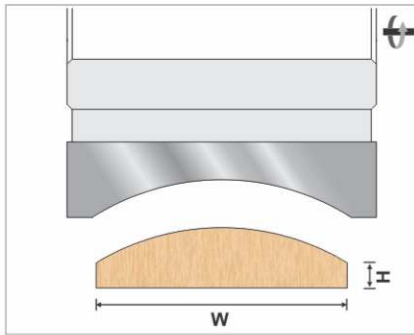

YTB 55		YTB 55 105				
ORDER CODE	DIA	WIDTH	BORE		TEETH	
YTB 55 105 A	125	50mm	30	31.75	35 3 / 4	
YTB 55 105 B	125	65mm	30	31.75	35 3 / 4	
YTB 55 105 C	125	75mm	30	31.75	35 3 / 4	
YTB 55 105 D	125	90mm	30	31.75	35 3 / 4	
YTB 55 105 E	125	100mm	30	31.75	35 3 / 4	

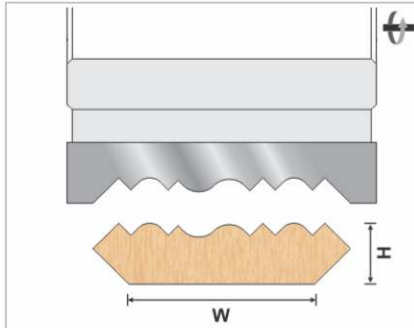

YTB 55		YTB 55 106				
ORDER CODE	DIA	WIDTH	BORE		TEETH	
YTB 55 106 A	125	50mm	30	31.75	35 3 / 4	
YTB 55 106 B	125	65mm	30	31.75	35 3 / 4	
YTB 55 106 C	125	75mm	30	31.75	35 3 / 4	
YTB 55 106 D	125	90mm	30	31.75	35 3 / 4	
YTB 55 106 E	125	100mm	30	31.75	35 3 / 4	

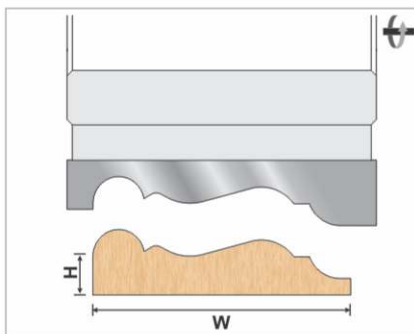

YTB 55		YTB 55 107				
ORDER CODE	DIA	WIDTH	BORE		TEETH	
YTB 55 107 A	125	50mm	30	31.75	35 3 / 4	
YTB 55 107 B	125	65mm	30	31.75	35 3 / 4	
YTB 55 107 C	125	75mm	30	31.75	35 3 / 4	
YTB 55 107 D	125	90mm	30	31.75	35 3 / 4	
YTB 55 107 E	125	100mm	30	31.75	35 3 / 4	

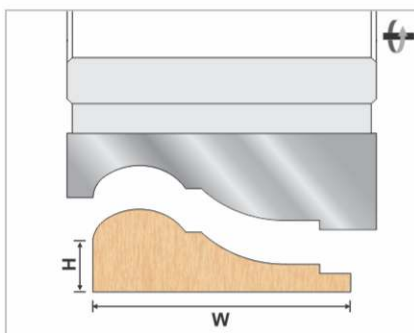

YTB 55		YTB 55 108				
ORDER CODE	DIA	WIDTH	BORE		TEETH	
YTB 55 108 A	125	50mm	30	31.75	35 3 / 4	
YTB 55 108 B	125	65mm	30	31.75	35 3 / 4	
YTB 55 108 C	125	75mm	30	31.75	35 3 / 4	
YTB 55 108 D	125	90mm	30	31.75	35 3 / 4	
YTB 55 108 E	125	100mm	30	31.75	35 3 / 4	

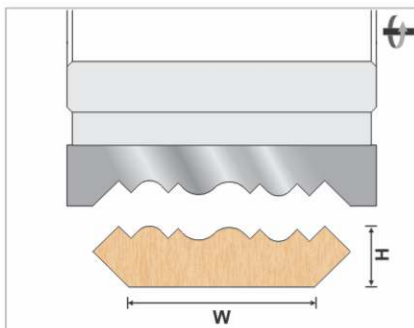

YTB 55		YTB 55 109				
ORDER CODE	DIA	WIDTH	BORE		TEETH	
YTB 55 109 A	125	50mm	30	31.75	35 3 / 4	
YTB 55 109 B	125	65mm	30	31.75	35 3 / 4	
YTB 55 109 C	125	75mm	30	31.75	35 3 / 4	
YTB 55 109 D	125	90mm	30	31.75	35 3 / 4	
YTB 55 109 E	125	100mm	30	31.75	35 3 / 4	

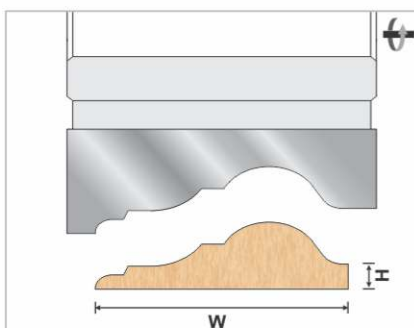

YTB 55		YTB 55 110				
ORDER CODE	DIA	WIDTH	BORE		TEETH	
YTB 55 110 A	125	50mm	30	31.75	35 3 / 4	
YTB 55 110 B	125	65mm	30	31.75	35 3 / 4	
YTB 55 110 C	125	75mm	30	31.75	35 3 / 4	
YTB 55 110 D	125	90mm	30	31.75	35 3 / 4	
YTB 55 110 E	125	100mm	30	31.75	35 3 / 4	

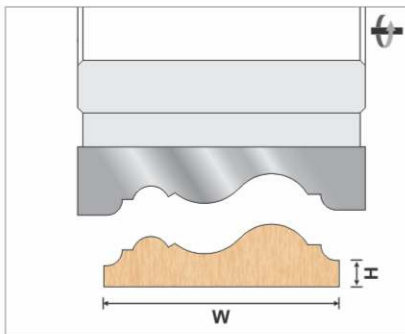

YTB 55		YTB 55 111				
ORDER CODE	DIA	WIDTH	BORE		TEETH	
YTB 55 111 A	125	50mm	30	31.75	35 3 / 4	
YTB 55 111 B	125	65mm	30	31.75	35 3 / 4	
YTB 55 111 C	125	75mm	30	31.75	35 3 / 4	
YTB 55 111 D	125	90mm	30	31.75	35 3 / 4	
YTB 55 111 E	125	100mm	30	31.75	35 3 / 4	

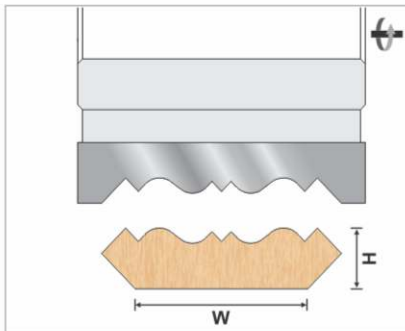

YTB 55		YTB 55 112				
ORDER CODE	DIA	WIDTH	BORE		TEETH	
YTB 55 112 A	125	50mm	30	31.75	35 3 / 4	
YTB 55 112 B	125	65mm	30	31.75	35 3 / 4	
YTB 55 112 C	125	75mm	30	31.75	35 3 / 4	
YTB 55 112 D	125	90mm	30	31.75	35 3 / 4	
YTB 55 112 E	125	100mm	30	31.75	35 3 / 4	

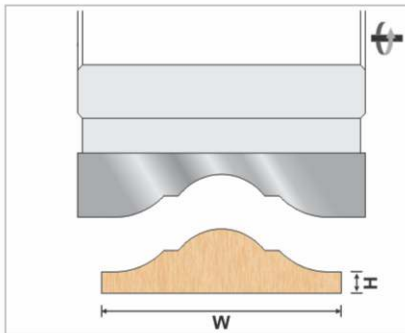

YTB 55		YTB 55 113				
ORDER CODE	DIA	WIDTH	BORE		TEETH	
YTB 55 113 A	125	50mm	30	31.75	35 3 / 4	
YTB 55 113 B	125	65mm	30	31.75	35 3 / 4	
YTB 55 113 C	125	75mm	30	31.75	35 3 / 4	
YTB 55 113 D	125	90mm	30	31.75	35 3 / 4	
YTB 55 113 E	125	100mm	30	31.75	35 3 / 4	

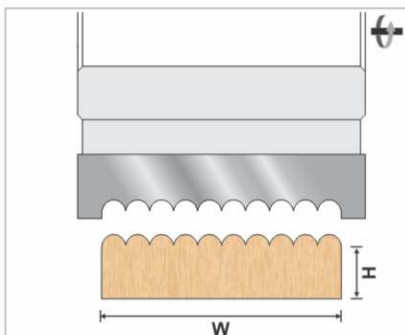

YTB 55		YTB 55 114				
ORDER CODE	DIA	WIDTH	BORE		TEETH	
YTB 55 114 A	125	50mm	30	31.75	35 3 / 4	
YTB 55 114 B	125	65mm	30	31.75	35 3 / 4	
YTB 55 114 C	125	75mm	30	31.75	35 3 / 4	
YTB 55 114 D	125	90mm	30	31.75	35 3 / 4	
YTB 55 114 E	125	100mm	30	31.75	35 3 / 4	

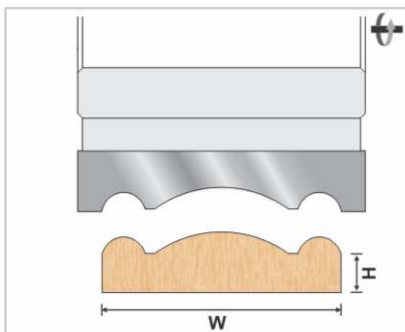

YTB 55		YTB 55 115				
ORDER CODE	DIA	WIDTH	BORE		TEETH	
YTB 55 115 A	125	50mm	30	31.75	35 3 / 4	
YTB 55 115 B	125	65mm	30	31.75	35 3 / 4	
YTB 55 115 C	125	75mm	30	31.75	35 3 / 4	
YTB 55 115 D	125	90mm	30	31.75	35 3 / 4	
YTB 55 115 E	125	100mm	30	31.75	35 3 / 4	

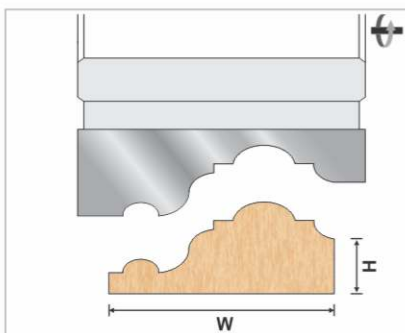

YTB 55		YTB 55 116				
ORDER CODE	DIA	WIDTH	BORE		TEETH	
YTB 55 116 A	125	50mm	30	31.75	35 3 / 4	
YTB 55 116 B	125	65mm	30	31.75	35 3 / 4	
YTB 55 116 C	125	75mm	30	31.75	35 3 / 4	
YTB 55 116 D	125	90mm	30	31.75	35 3 / 4	
YTB 55 116 E	125	100mm	30	31.75	35 3 / 4	



YTB 55 117

YTB 55						
ORDER CODE	DIA	WIDTH	BORE		TEETH	
YTB 55 117 A	125	50mm	30	31.75	35	3 / 4
YTB 55 117 B	125	65mm	30	31.75	35	3 / 4
YTB 55 117 C	125	75mm	30	31.75	35	3 / 4
YTB 55 117 D	125	90mm	30	31.75	35	3 / 4
YTB 55 117 E	125	100mm	30	31.75	35	3 / 4



YTB 55 118

YTB 55						
ORDER CODE	DIA	WIDTH	BORE		TEETH	
YTB 55 118 A	125	50mm	30	31.75	35	3 / 4
YTB 55 118 B	125	65mm	30	31.75	35	3 / 4
YTB 55 118 C	125	75mm	30	31.75	35	3 / 4
YTB 55 118 D	125	90mm	30	31.75	35	3 / 4
YTB 55 118 E	125	100mm	30	31.75	35	3 / 4



YTB 55 119

YTB 55						
ORDER CODE	DIA	WIDTH	BORE		TEETH	
YTB 55 119 A	125	50mm	30	31.75	35	3 / 4
YTB 55 119 B	125	65mm	30	31.75	35	3 / 4
YTB 55 119 C	125	75mm	30	31.75	35	3 / 4
YTB 55 119 D	125	90mm	30	31.75	35	3 / 4
YTB 55 119 E	125	100mm	30	31.75	35	3 / 4



YTB 55 120

YTB 55						
ORDER CODE	DIA	WIDTH	BORE		TEETH	
YTB 55 120 A	125	50mm	30	31.75	35	3 / 4
YTB 55 120 B	125	65mm	30	31.75	35	3 / 4
YTB 55 120 C	125	75mm	30	31.75	35	3 / 4
YTB 55 120 D	125	90mm	30	31.75	35	3 / 4
YTB 55 120 E	125	100mm	30	31.75	35	3 / 4



YTB 55 121

YTB 55						
ORDER CODE	DIA	WIDTH	BORE		TEETH	
YTB 55 121 A	125	50mm	30	31.75	35	3 / 4
YTB 55 121 B	125	65mm	30	31.75	35	3 / 4
YTB 55 121 C	125	75mm	30	31.75	35	3 / 4
YTB 55 121 D	125	90mm	30	31.75	35	3 / 4
YTB 55 121 E	125	100mm	30	31.75	35	3 / 4



YTB 55 122

YTB 55						
ORDER CODE	DIA	WIDTH	BORE		TEETH	
YTB 55 122 A	125	50mm	30	31.75	35	3 / 4
YTB 55 122 B	125	65mm	30	31.75	35	3 / 4
YTB 55 122 C	125	75mm	30	31.75	35	3 / 4
YTB 55 122 D	125	90mm	30	31.75	35	3 / 4
YTB 55 122 E	125	100mm	30	31.75	35	3 / 4

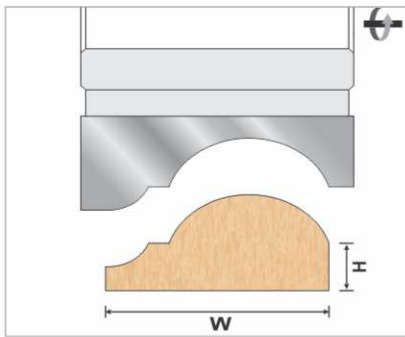

YTB 55		YTB 55 123				
ORDER CODE	DIA	WIDTH	BORE		TEETH	
YTB 55 123 A	125	50mm	30	31.75	35 3 / 4	
YTB 55 123 B	125	65mm	30	31.75	35 3 / 4	
YTB 55 123 C	125	75mm	30	31.75	35 3 / 4	
YTB 55 123 D	125	90mm	30	31.75	35 3 / 4	
YTB 55 123 E	125	100mm	30	31.75	35 3 / 4	

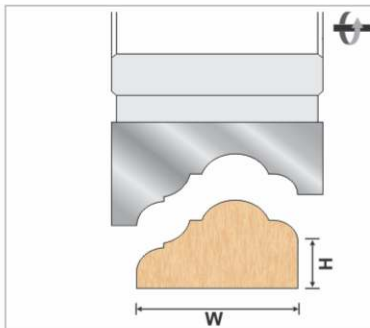

YTB 55		YTB 55 124				
ORDER CODE	DIA	WIDTH	BORE		TEETH	
YTB 55 124 A	125	50mm	30	31.75	35 3 / 4	
YTB 55 124 B	125	65mm	30	31.75	35 3 / 4	
YTB 55 124 C	125	75mm	30	31.75	35 3 / 4	
YTB 55 124 D	125	90mm	30	31.75	35 3 / 4	
YTB 55 124 E	125	100mm	30	31.75	35 3 / 4	

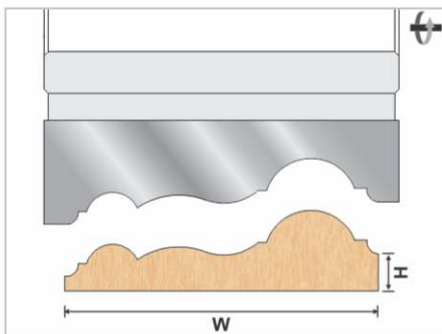

YTB 55		YTB 55 125				
ORDER CODE	DIA	WIDTH	BORE		TEETH	
YTB 55 125 A	125	50mm	30	31.75	35 3 / 4	
YTB 55 125 B	125	65mm	30	31.75	35 3 / 4	
YTB 55 125 C	125	75mm	30	31.75	35 3 / 4	
YTB 55 125 D	125	90mm	30	31.75	35 3 / 4	
YTB 55 125 E	125	100mm	30	31.75	35 3 / 4	

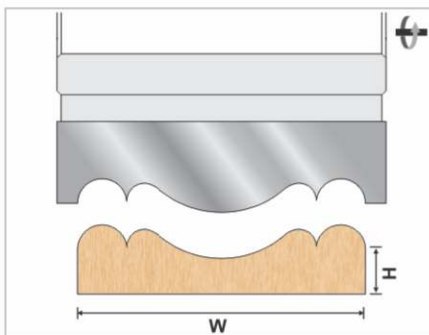

YTB 55		YTB 55 126				
ORDER CODE	DIA	WIDTH	BORE		TEETH	
YTB 55 126 A	125	50mm	30	31.75	35 3 / 4	
YTB 55 126 B	125	65mm	30	31.75	35 3 / 4	
YTB 55 126 C	125	75mm	30	31.75	35 3 / 4	
YTB 55 126 D	125	90mm	30	31.75	35 3 / 4	
YTB 55 126 E	125	100mm	30	31.75	35 3 / 4	

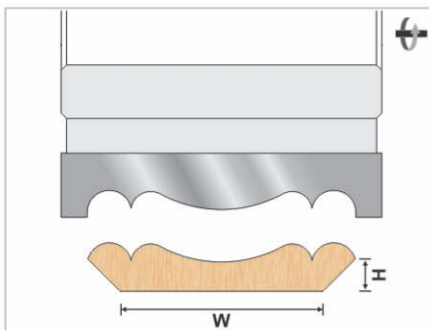

YTB 55		YTB 55 127				
ORDER CODE	DIA	WIDTH	BORE		TEETH	
YTB 55 127 A	125	50mm	30	31.75	35 3 / 4	
YTB 55 127 B	125	65mm	30	31.75	35 3 / 4	
YTB 55 127 C	125	75mm	30	31.75	35 3 / 4	
YTB 55 127 D	125	90mm	30	31.75	35 3 / 4	
YTB 55 127 E	125	100mm	30	31.75	35 3 / 4	

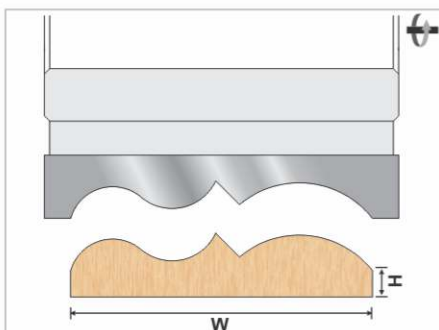

YTB 55		YTB 55 128				
ORDER CODE	DIA	WIDTH	BORE		TEETH	
YTB 55 128 A	125	50mm	30	31.75	35 3 / 4	
YTB 55 128 B	125	65mm	30	31.75	35 3 / 4	
YTB 55 128 C	125	75mm	30	31.75	35 3 / 4	
YTB 55 128 D	125	90mm	30	31.75	35 3 / 4	
YTB 55 128 E	125	100mm	30	31.75	35 3 / 4	

Profile Cutter For Molder Machine T.C.T (Brazed) - YTB 55

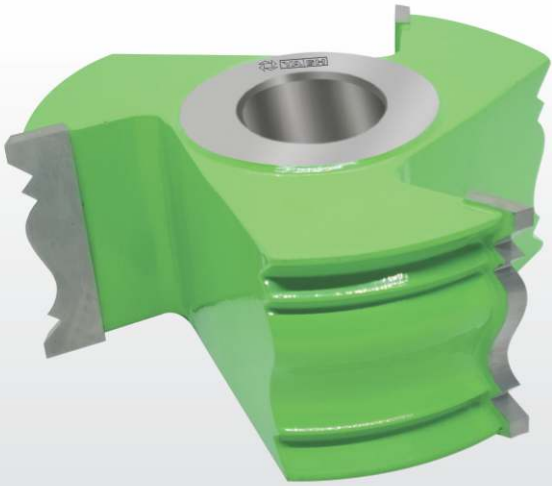

Technical Details :

Spindle Moulder & Four Side Moulder Machines

Application :

Hard Wood & MDF

WOOD WIDTH :
50mm, 65mm, 75mm, 90mm, 100mm

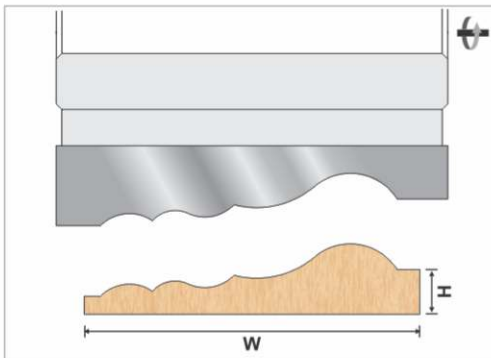

YTB 55		YTB 55 129				
ORDER CODE	DIA	WIDTH	BORE		TEETH	
YTB 55 129 A	125	50mm	30	31.75	35	3 / 4
YTB 55 129 B	125	65mm	30	31.75	35	3 / 4
YTB 55 129 C	125	75mm	30	31.75	35	3 / 4
YTB 55 129 D	125	90mm	30	31.75	35	3 / 4
YTB 55 129 E	125	100mm	30	31.75	35	3 / 4

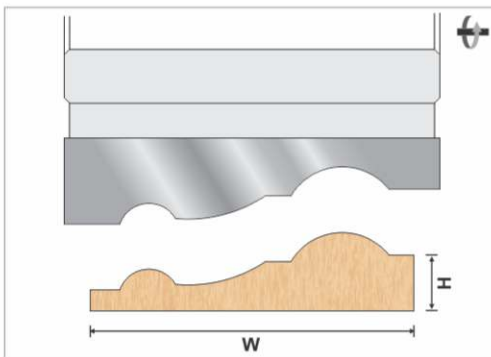

YTB 55		YTB 55 130				
ORDER CODE	DIA	WIDTH	BORE		TEETH	
YTB 55 130 A	125	50mm	30	31.75	35	3 / 4
YTB 55 130 B	125	65mm	30	31.75	35	3 / 4
YTB 55 130 C	125	75mm	30	31.75	35	3 / 4
YTB 55 130 D	125	90mm	30	31.75	35	3 / 4
YTB 55 130 E	125	100mm	30	31.75	35	3 / 4

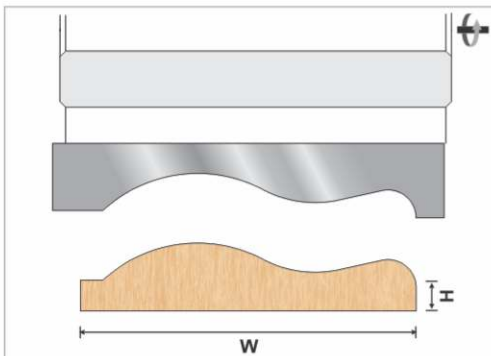

YTB 55		YTB 55 131				
ORDER CODE	DIA	WIDTH	BORE		TEETH	
YTB 55 131 A	125	50mm	30	31.75	35	3 / 4
YTB 55 131 B	125	65mm	30	31.75	35	3 / 4
YTB 55 131 C	125	75mm	30	31.75	35	3 / 4
YTB 55 131 D	125	90mm	30	31.75	35	3 / 4
YTB 55 131 E	125	100mm	30	31.75	35	3 / 4

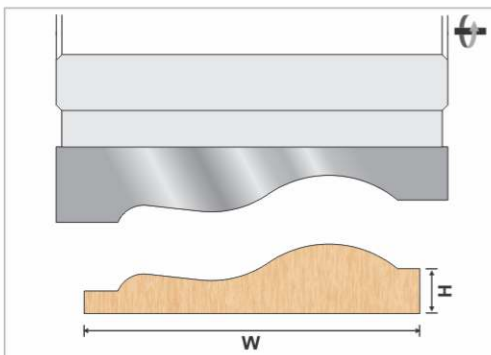

YTB 55		YTB 55 132				
ORDER CODE	DIA	WIDTH	BORE		TEETH	
YTB 55 132 A	125	50mm	30	31.75	35	3 / 4
YTB 55 132 B	125	65mm	30	31.75	35	3 / 4
YTB 55 132 C	125	75mm	30	31.75	35	3 / 4
YTB 55 132 D	125	90mm	30	31.75	35	3 / 4
YTB 55 132 E	125	100mm	30	31.75	35	3 / 4

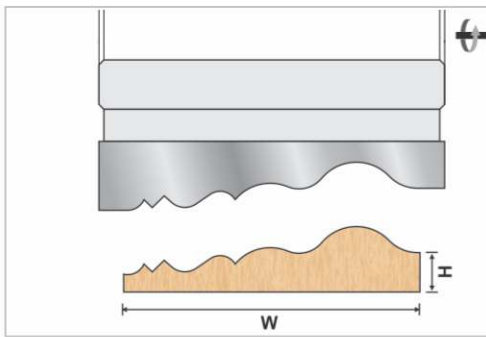

YTB 55		YTB 55 133				
ORDER CODE	DIA	WIDTH	BORE		TEETH	
YTB 55 133 A	125	50mm	30	31.75	35 3 / 4	
YTB 55 133 B	125	65mm	30	31.75	35 3 / 4	
YTB 55 133 C	125	75mm	30	31.75	35 3 / 4	
YTB 55 133 D	125	90mm	30	31.75	35 3 / 4	
YTB 55 133 E	125	100mm	30	31.75	35 3 / 4	

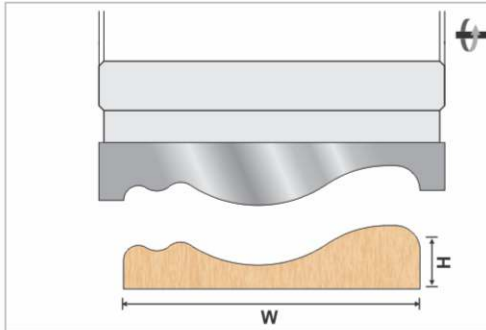

YTB 55		YTB 55 134				
ORDER CODE	DIA	WIDTH	BORE		TEETH	
YTB 55 134 A	125	50mm	30	31.75	35 3 / 4	
YTB 55 134 B	125	65mm	30	31.75	35 3 / 4	
YTB 55 134 C	125	75mm	30	31.75	35 3 / 4	
YTB 55 134 D	125	90mm	30	31.75	35 3 / 4	
YTB 55 134 E	125	100mm	30	31.75	35 3 / 4	

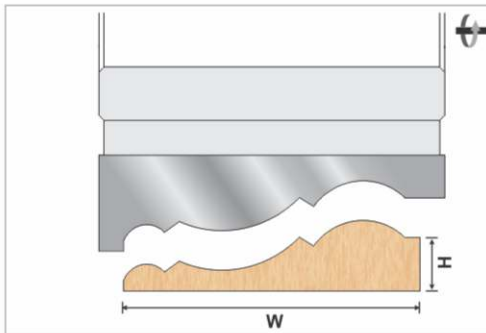

YTB 55		YTB 55 135				
ORDER CODE	DIA	WIDTH	BORE		TEETH	
YTB 55 135 A	125	50mm	30	31.75	35 3 / 4	
YTB 55 135 B	125	65mm	30	31.75	35 3 / 4	
YTB 55 135 C	125	75mm	30	31.75	35 3 / 4	
YTB 55 135 D	125	90mm	30	31.75	35 3 / 4	
YTB 55 135 E	125	100mm	30	31.75	35 3 / 4	

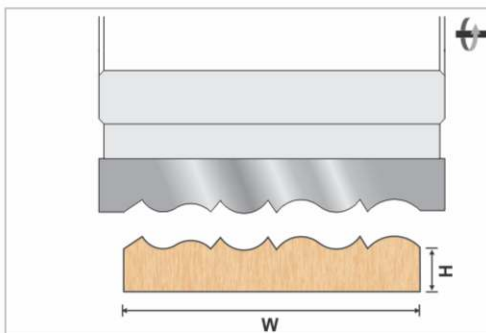

YTB 55		YTB 55 136				
ORDER CODE	DIA	WIDTH	BORE		TEETH	
YTB 55 136 A	125	50mm	30	31.75	35 3 / 4	
YTB 55 136 B	125	65mm	30	31.75	35 3 / 4	
YTB 55 136 C	125	75mm	30	31.75	35 3 / 4	
YTB 55 136 D	125	90mm	30	31.75	35 3 / 4	
YTB 55 136 E	125	100mm	30	31.75	35 3 / 4	

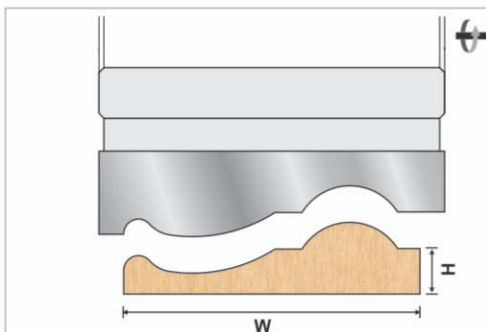

YTB 55		YTB 55 137				
ORDER CODE	DIA	WIDTH	BORE		TEETH	
YTB 55 137 A	125	50mm	30	31.75	35 3 / 4	
YTB 55 137 B	125	65mm	30	31.75	35 3 / 4	
YTB 55 137 C	125	75mm	30	31.75	35 3 / 4	
YTB 55 137 D	125	90mm	30	31.75	35 3 / 4	
YTB 55 137 E	125	100mm	30	31.75	35 3 / 4	

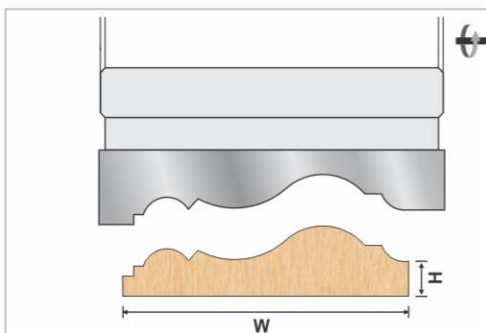

YTB 55		YTB 55 138				
ORDER CODE	DIA	WIDTH	BORE		TEETH	
YTB 55 138 A	125	50mm	30	31.75	35 3 / 4	
YTB 55 138 B	125	65mm	30	31.75	35 3 / 4	
YTB 55 138 C	125	75mm	30	31.75	35 3 / 4	
YTB 55 138 D	125	90mm	30	31.75	35 3 / 4	
YTB 55 138 E	125	100mm	30	31.75	35 3 / 4	

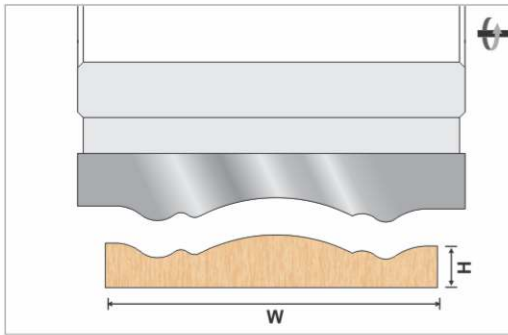

YTB 55 139

YTB 55						
ORDER CODE	DIA	WIDTH	BORE		TEETH	
YTB 55 139 A	125	50mm	30	31.75	35	3 / 4
YTB 55 139 B	125	65mm	30	31.75	35	3 / 4
YTB 55 139 C	125	75mm	30	31.75	35	3 / 4
YTB 55 139 D	125	90mm	30	31.75	35	3 / 4
YTB 55 139 E	125	100mm	30	31.75	35	3 / 4

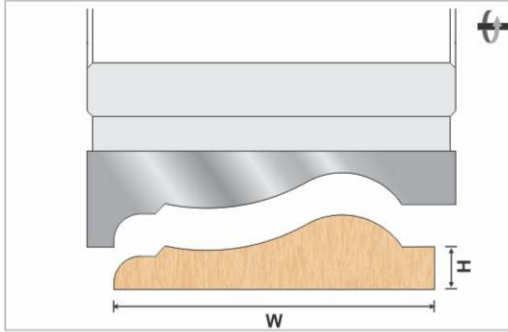

YTB 55 140

YTB 55						
ORDER CODE	DIA	WIDTH	BORE		TEETH	
YTB 55 140 A	125	50mm	30	31.75	35	3 / 4
YTB 55 140 B	125	65mm	30	31.75	35	3 / 4
YTB 55 140 C	125	75mm	30	31.75	35	3 / 4
YTB 55 140 D	125	90mm	30	31.75	35	3 / 4
YTB 55 140 E	125	100mm	30	31.75	35	3 / 4

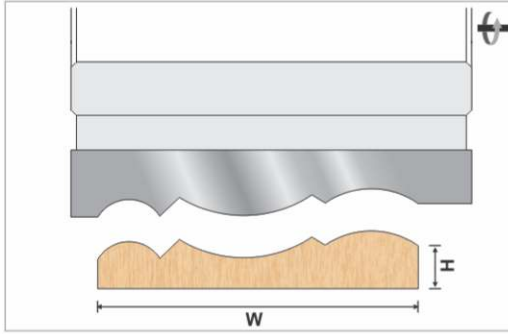

YTB 55 141

YTB 55						
ORDER CODE	DIA	WIDTH	BORE		TEETH	
YTB 55 141 A	125	50mm	30	31.75	35	3 / 4
YTB 55 141 B	125	65mm	30	31.75	35	3 / 4
YTB 55 141 C	125	75mm	30	31.75	35	3 / 4
YTB 55 141 D	125	90mm	30	31.75	35	3 / 4
YTB 55 141 E	125	100mm	30	31.75	35	3 / 4

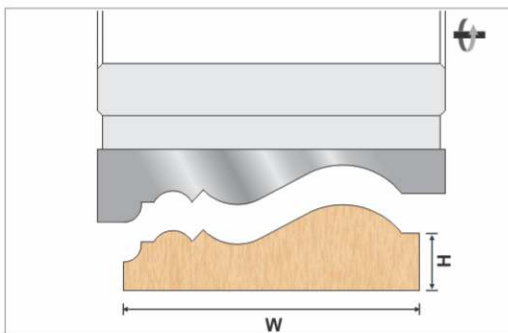

YTB 55 142

YTB 55						
ORDER CODE	DIA	WIDTH	BORE		TEETH	
YTB 55 142 A	125	50mm	30	31.75	35	3 / 4
YTB 55 142 B	125	65mm	30	31.75	35	3 / 4
YTB 55 142 C	125	75mm	30	31.75	35	3 / 4
YTB 55 142 D	125	90mm	30	31.75	35	3 / 4
YTB 55 142 E	125	100mm	30	31.75	35	3 / 4

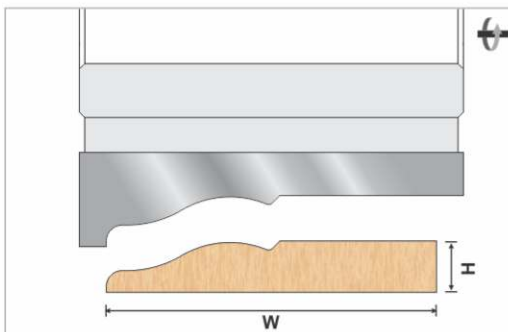

YTB 55 143

YTB 55						
ORDER CODE	DIA	WIDTH	BORE		TEETH	
YTB 55 143 A	125	50mm	30	31.75	35	3 / 4
YTB 55 143 B	125	65mm	30	31.75	35	3 / 4
YTB 55 143 C	125	75mm	30	31.75	35	3 / 4
YTB 55 143 D	125	90mm	30	31.75	35	3 / 4
YTB 55 143 E	125	100mm	30	31.75	35	3 / 4

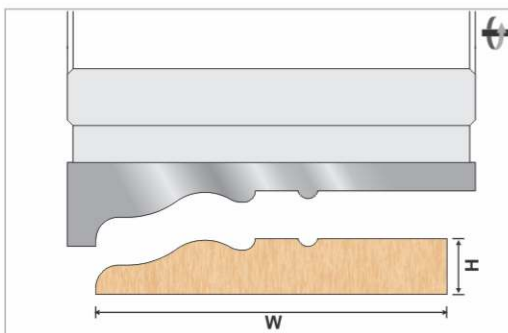

YTB 55 144

YTB 55						
ORDER CODE	DIA	WIDTH	BORE		TEETH	
YTB 55 144 A	125	50mm	30	31.75	35	3 / 4
YTB 55 144 B	125	65mm	30	31.75	35	3 / 4
YTB 55 144 C	125	75mm	30	31.75	35	3 / 4
YTB 55 144 D	125	90mm	30	31.75	35	3 / 4
YTB 55 144 E	125	100mm	30	31.75	35	3 / 4

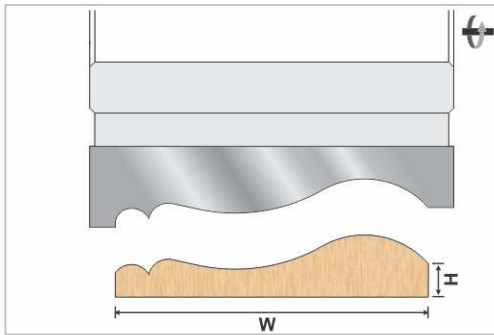

YTB 55 145

YTB 55						
ORDER CODE	DIA	WIDTH	BORE		TEETH	
YTB 55 145 A	125	50mm	30	31.75	35	3 / 4
YTB 55 145 B	125	65mm	30	31.75	35	3 / 4
YTB 55 145 C	125	75mm	30	31.75	35	3 / 4
YTB 55 145 D	125	90mm	30	31.75	35	3 / 4
YTB 55 145 E	125	100mm	30	31.75	35	3 / 4

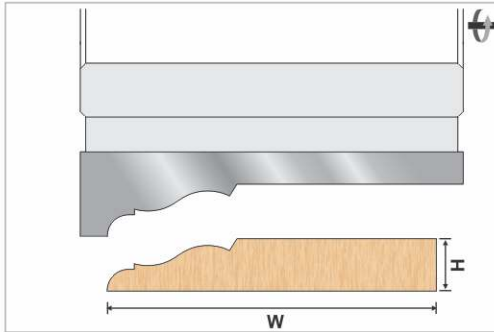

YTB 55 146

YTB 55						
ORDER CODE	DIA	WIDTH	BORE		TEETH	
YTB 55 146 A	125	50mm	30	31.75	35	3 / 4
YTB 55 146 B	125	65mm	30	31.75	35	3 / 4
YTB 55 146 C	125	75mm	30	31.75	35	3 / 4
YTB 55 146 D	125	90mm	30	31.75	35	3 / 4
YTB 55 146 E	125	100mm	30	31.75	35	3 / 4

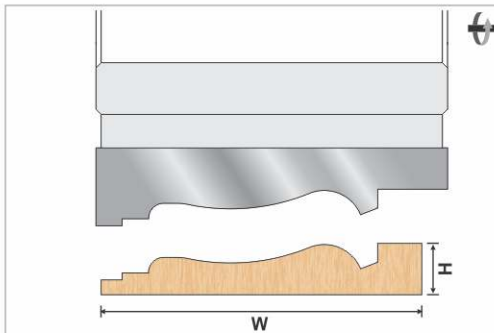

YTB 55 147

YTB 55						
ORDER CODE	DIA	WIDTH	BORE		TEETH	
YTB 55 147 A	125	50mm	30	31.75	35	3 / 4
YTB 55 147 B	125	65mm	30	31.75	35	3 / 4
YTB 55 147 C	125	75mm	30	31.75	35	3 / 4
YTB 55 147 D	125	90mm	30	31.75	35	3 / 4
YTB 55 147 E	125	100mm	30	31.75	35	3 / 4

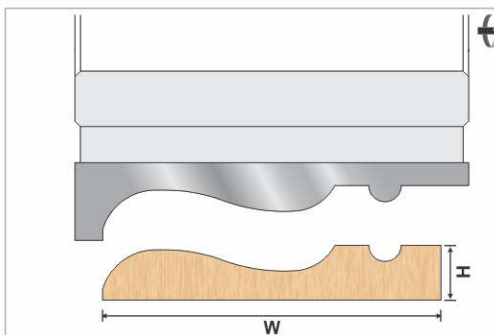

YTB 55 148

YTB 55						
ORDER CODE	DIA	WIDTH	BORE		TEETH	
YTB 55 148 A	125	50mm	30	31.75	35	3 / 4
YTB 55 148 B	125	65mm	30	31.75	35	3 / 4
YTB 55 148 C	125	75mm	30	31.75	35	3 / 4
YTB 55 148 D	125	90mm	30	31.75	35	3 / 4
YTB 55 148 E	125	100mm	30	31.75	35	3 / 4

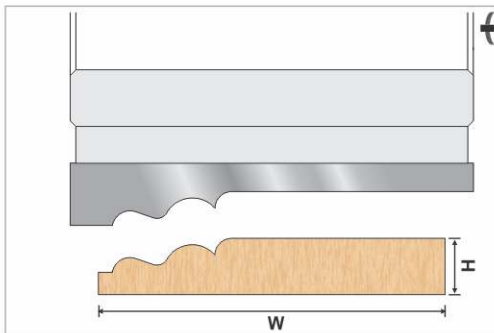

YTB 55 149

YTB 55						
ORDER CODE	DIA	WIDTH	BORE		TEETH	
YTB 55 149 A	125	50mm	30	31.75	35	3 / 4
YTB 55 149 B	125	65mm	30	31.75	35	3 / 4
YTB 55 149 C	125	75mm	30	31.75	35	3 / 4
YTB 55 149 D	125	90mm	30	31.75	35	3 / 4
YTB 55 149 E	125	100mm	30	31.75	35	3 / 4

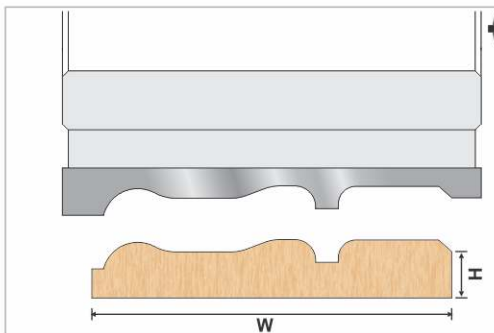

YTB 55 150

YTB 55						
ORDER CODE	DIA	WIDTH	BORE		TEETH	
YTB 55 150 A	125	50mm	30	31.75	35	3 / 4
YTB 55 150 B	125	65mm	30	31.75	35	3 / 4
YTB 55 150 C	125	75mm	30	31.75	35	3 / 4
YTB 55 150 D	125	90mm	30	31.75	35	3 / 4
YTB 55 150 E	125	100mm	30	31.75	35	3 / 4

Multi Frame Cutter For Moulder Machine T.C.T (Brazed) - YTB 56

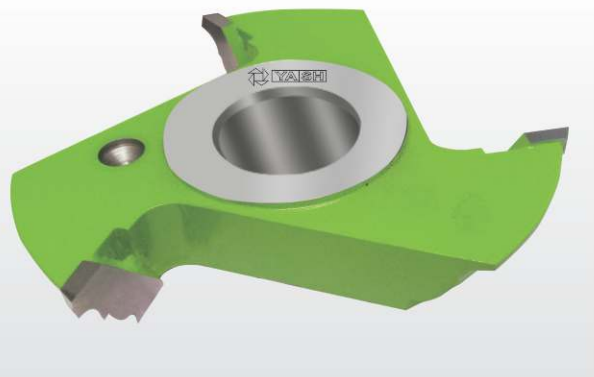

Technical Details :

Spindle Moulder & Four Side Moulder Machines

Application :

Hard Wood & MDF

YTB 56

ORDER CODE	DIA	MOULDING SIZE	BORE		TEETH
YTB 56 101 A	125	15 x 15	30	31.75 35	3 / 4
YTB 56 101 B	125	18 x 18	30	31.75 35	3 / 4
YTB 56 101 C	125	20 x 20	30	31.75 35	3 / 4
YTB 56 101 D	125	22 x 22	30	31.75 35	3 / 4
YTB 56 101 E	125	25 x 25	30	31.75 35	3 / 4
YTB 56 101 F	150	28 x 15	30	31.75 35	3 / 4
YTB 56 101 G	150	28 x 28	30	31.75 35	3 / 4
YTB 56 101 H	150	32 x 18	30	31.75 35	3 / 4
YTB 56 101 I	150	32 x 32	30	31.75 35	3 / 4
YTB 56 101 J	160	36 x 15	30	31.75 35	3 / 4
YTB 56 101 K	160	36 x 18	30	31.75 35	3 / 4
YTB 56 101 L	160	36 x 22	30	31.75 35	3 / 4
YTB 56 101 M	160	36 x 28	30	31.75 35	3 / 4
YTB 56 101 N	160	36 x 36	30	31.75 35	3 / 4
YTB 56 101 O	170	45 x 45	30	31.75 35	3 / 4

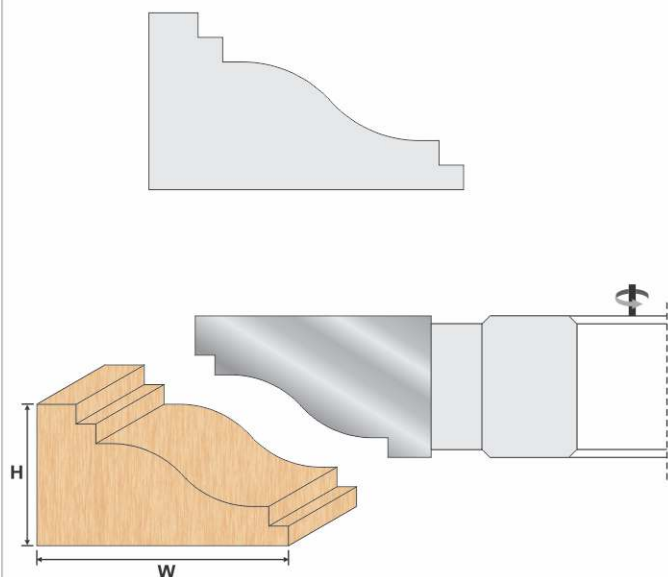

YTB 56

ORDER CODE	DIA	MOULDING SIZE	BORE		TEETH
YTB 56 102 A	125	15 x 15	30	31.75 35	3 / 4
YTB 56 102 B	125	18 x 18	30	31.75 35	3 / 4
YTB 56 102 C	125	20 x 20	30	31.75 35	3 / 4
YTB 56 102 D	125	22 x 22	30	31.75 35	3 / 4
YTB 56 102 E	125	25 x 25	30	31.75 35	3 / 4
YTB 56 102 F	150	28 x 15	30	31.75 35	3 / 4
YTB 56 102 G	150	28 x 28	30	31.75 35	3 / 4
YTB 56 102 H	150	32 x 18	30	31.75 35	3 / 4
YTB 56 102 I	150	32 x 32	30	31.75 35	3 / 4
YTB 56 102 J	160	36 x 15	30	31.75 35	3 / 4
YTB 56 102 K	160	36 x 18	30	31.75 35	3 / 4
YTB 56 102 L	160	36 x 22	30	31.75 35	3 / 4
YTB 56 102 M	160	36 x 28	30	31.75 35	3 / 4
YTB 56 102 N	160	36 x 36	30	31.75 35	3 / 4
YTB 56 102 O	170	45 x 45	30	31.75 35	3 / 4

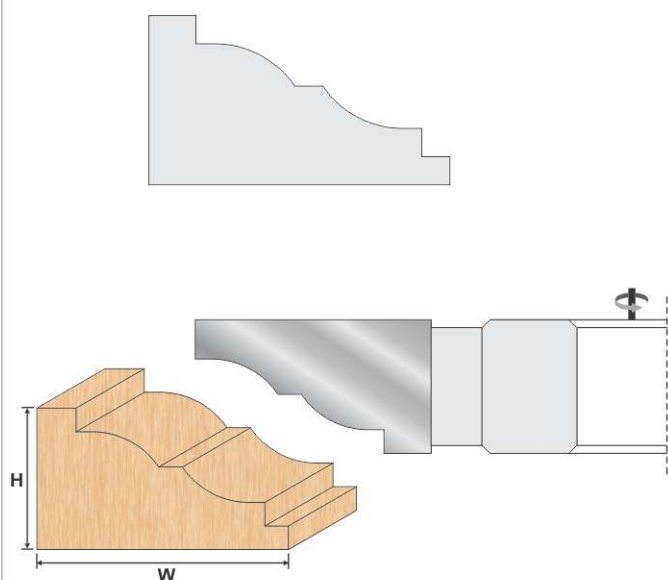

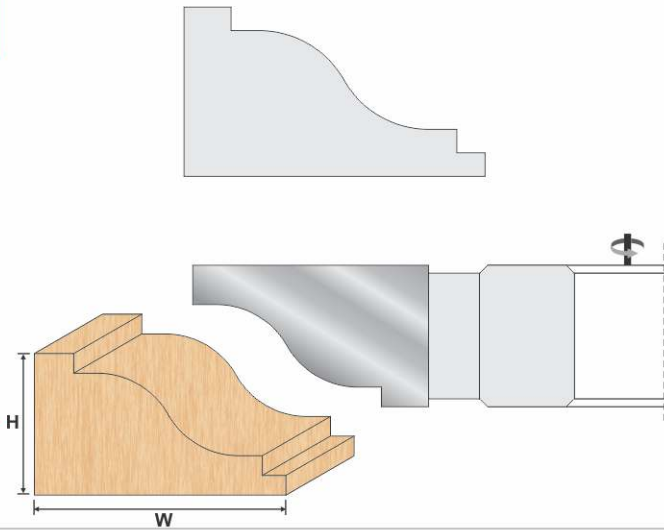

YTB 56

ORDER CODE	DIA	MOULDING SIZE	BORE		TEETH
YTB 56 103 A	125	15 x 15	30	31.75 35	3 / 4
YTB 56 103 B	125	18 x 18	30	31.75 35	3 / 4
YTB 56 103 C	125	20 x 20	30	31.75 35	3 / 4
YTB 56 103 D	125	22 x 22	30	31.75 35	3 / 4
YTB 56 103 E	125	25 x 25	30	31.75 35	3 / 4
YTB 56 103 F	150	28 x 15	30	31.75 35	3 / 4
YTB 56 103 G	150	28 x 28	30	31.75 35	3 / 4
YTB 56 103 H	150	32 x 18	30	31.75 35	3 / 4
YTB 56 103 I	150	32 x 32	30	31.75 35	3 / 4
YTB 56 103 J	160	36 x 15	30	31.75 35	3 / 4
YTB 56 103 K	160	36 x 18	30	31.75 35	3 / 4
YTB 56 103 L	160	36 x 22	30	31.75 35	3 / 4
YTB 56 103 M	160	36 x 28	30	31.75 35	3 / 4
YTB 56 103 N	160	36 x 36	30	31.75 35	3 / 4
YTB 56 103 O	170	45 x 45	30	31.75 35	3 / 4

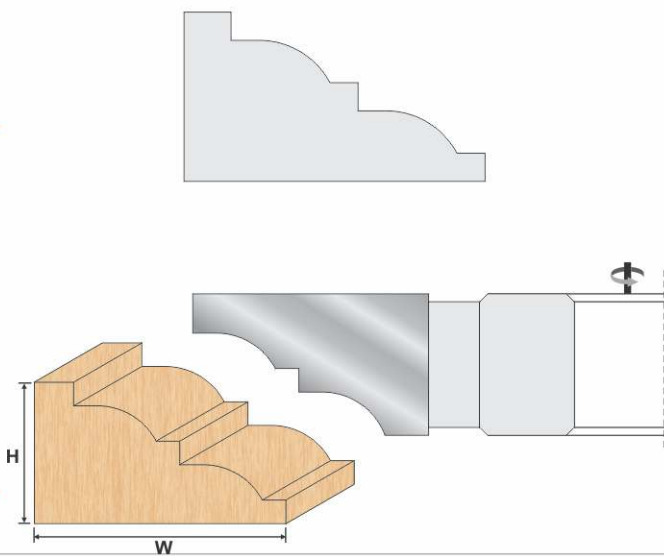

YTB 56

ORDER CODE	DIA	MOULDING SIZE	BORE		TEETH
YTB 56 104 A	125	15 x 15	30	31.75 35	3 / 4
YTB 56 104 B	125	18 x 18	30	31.75 35	3 / 4
YTB 56 104 C	125	20 x 20	30	31.75 35	3 / 4
YTB 56 104 D	125	22 x 22	30	31.75 35	3 / 4
YTB 56 104 E	125	25 x 25	30	31.75 35	3 / 4
YTB 56 104 F	150	28 x 15	30	31.75 35	3 / 4
YTB 56 104 G	150	28 x 28	30	31.75 35	3 / 4
YTB 56 104 H	150	32 x 18	30	31.75 35	3 / 4
YTB 56 104 I	150	32 x 32	30	31.75 35	3 / 4
YTB 56 104 J	160	36 x 15	30	31.75 35	3 / 4
YTB 56 104 K	160	36 x 18	30	31.75 35	3 / 4
YTB 56 104 L	160	36 x 22	30	31.75 35	3 / 4
YTB 56 104 M	160	36 x 28	30	31.75 35	3 / 4
YTB 56 104 N	160	36 x 36	30	31.75 35	3 / 4
YTB 56 104 O	170	45 x 45	30	31.75 35	3 / 4

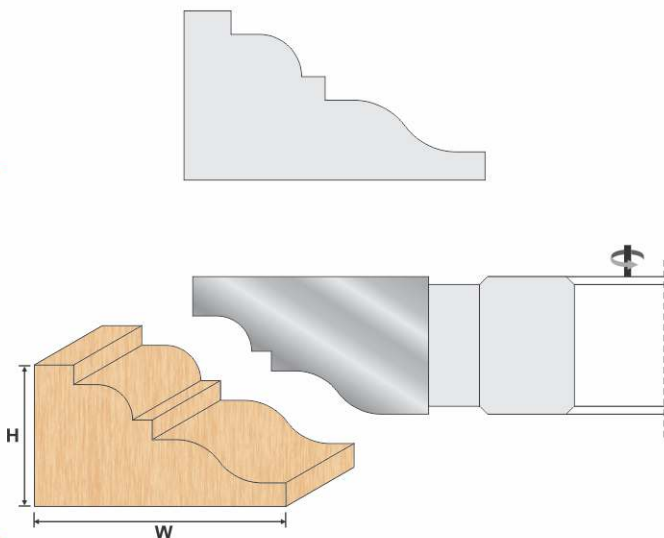

YTB 56

ORDER CODE	DIA	MOULDING SIZE	BORE		TEETH
YTB 56 105 A	125	15 x 15	30	31.75 35	3 / 4
YTB 56 105 B	125	18 x 18	30	31.75 35	3 / 4
YTB 56 105 C	125	20 x 20	30	31.75 35	3 / 4
YTB 56 105 D	125	22 x 22	30	31.75 35	3 / 4
YTB 56 105 E	125	25 x 25	30	31.75 35	3 / 4
YTB 56 105 F	150	28 x 15	30	31.75 35	3 / 4
YTB 56 105 G	150	28 x 28	30	31.75 35	3 / 4
YTB 56 105 H	150	32 x 18	30	31.75 35	3 / 4
YTB 56 105 I	150	32 x 32	30	31.75 35	3 / 4
YTB 56 105 J	160	36 x 15	30	31.75 35	3 / 4
YTB 56 105 K	160	36 x 18	30	31.75 35	3 / 4
YTB 56 105 L	160	36 x 22	30	31.75 35	3 / 4
YTB 56 105 M	160	36 x 28	30	31.75 35	3 / 4
YTB 56 105 N	160	36 x 36	30	31.75 35	3 / 4
YTB 56 105 O	170	45 x 45	30	31.75 35	3 / 4

Multi Frame Cutter For Molder Machine T.C.T
(Brazed) - YTB 56

YTB 56

ORDER CODE	DIA	MOULDING SIZE	BORE		TEETH
YTB 56 106 A	125	15 x 15	30	31.75 35	3 / 4
YTB 56 106 B	125	18 x 18	30	31.75 35	3 / 4
YTB 56 106 C	125	20 x 20	30	31.75 35	3 / 4
YTB 56 106 D	125	22 x 22	30	31.75 35	3 / 4
YTB 56 106 E	125	25 x 25	30	31.75 35	3 / 4
YTB 56 106 F	150	28 x 15	30	31.75 35	3 / 4
YTB 56 106 G	150	28 x 28	30	31.75 35	3 / 4
YTB 56 106 H	150	32 x 18	30	31.75 35	3 / 4
YTB 56 106 I	150	32 x 32	30	31.75 35	3 / 4
YTB 56 106 J	160	36 x 15	30	31.75 35	3 / 4
YTB 56 106 K	160	36 x 18	30	31.75 35	3 / 4
YTB 56 106 L	160	36 x 22	30	31.75 35	3 / 4
YTB 56 106 M	160	36 x 28	30	31.75 35	3 / 4
YTB 56 106 N	160	36 x 36	30	31.75 35	3 / 4
YTB 56 106 O	170	45 x 45	30	31.75 35	3 / 4

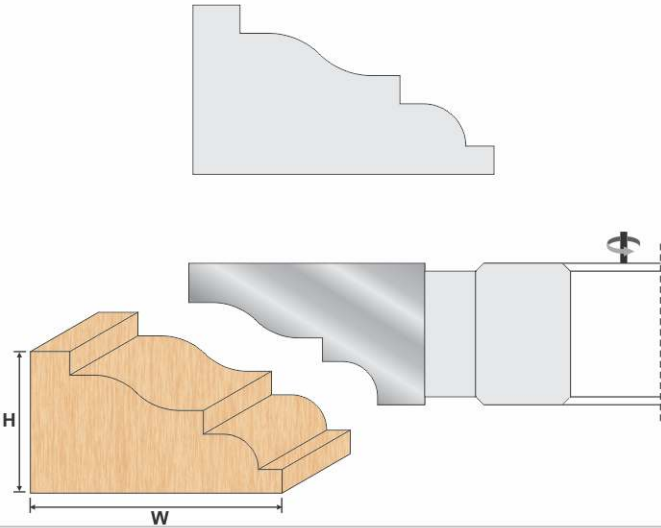

YTB 56

ORDER CODE	DIA	MOULDING SIZE	BORE		TEETH
YTB 56 107 A	125	15 x 15	30	31.75 35	3 / 4
YTB 56 107 B	125	18 x 18	30	31.75 35	3 / 4
YTB 56 107 C	125	20 x 20	30	31.75 35	3 / 4
YTB 56 107 D	125	22 x 22	30	31.75 35	3 / 4
YTB 56 107 E	125	25 x 25	30	31.75 35	3 / 4
YTB 56 107 F	150	28 x 15	30	31.75 35	3 / 4
YTB 56 107 G	150	28 x 28	30	31.75 35	3 / 4
YTB 56 107 H	150	32 x 18	30	31.75 35	3 / 4
YTB 56 107 I	150	32 x 32	30	31.75 35	3 / 4
YTB 56 107 J	160	36 x 15	30	31.75 35	3 / 4
YTB 56 107 K	160	36 x 18	30	31.75 35	3 / 4
YTB 56 107 L	160	36 x 22	30	31.75 35	3 / 4
YTB 56 107 M	160	36 x 28	30	31.75 35	3 / 4
YTB 56 107 N	160	36 x 36	30	31.75 35	3 / 4
YTB 56 107 O	170	45 x 45	30	31.75 35	3 / 4

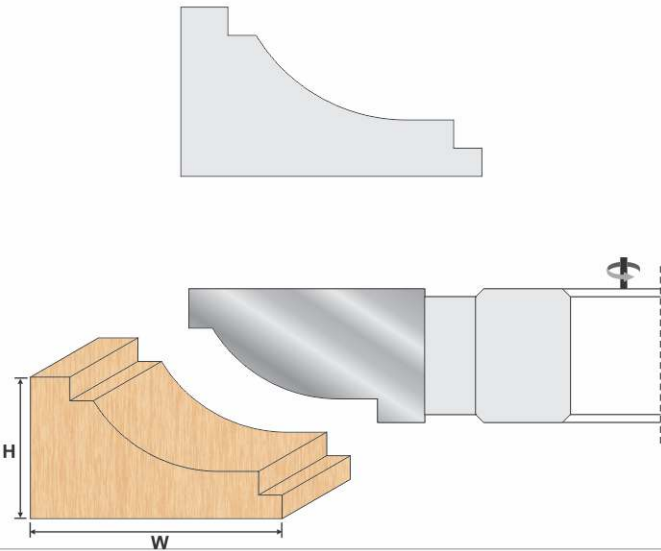

YTB 56

ORDER CODE	DIA	MOULDING SIZE	BORE		TEETH
YTB 56 108 A	125	15 x 15	30	31.75 35	3 / 4
YTB 56 108 B	125	18 x 18	30	31.75 35	3 / 4
YTB 56 108 C	125	20 x 20	30	31.75 35	3 / 4
YTB 56 108 D	125	22 x 22	30	31.75 35	3 / 4
YTB 56 108 E	125	25 x 25	30	31.75 35	3 / 4
YTB 56 108 F	150	28 x 15	30	31.75 35	3 / 4
YTB 56 108 G	150	28 x 28	30	31.75 35	3 / 4
YTB 56 108 H	150	32 x 18	30	31.75 35	3 / 4
YTB 56 108 I	150	32 x 32	30	31.75 35	3 / 4
YTB 56 108 J	160	36 x 15	30	31.75 35	3 / 4
YTB 56 108 K	160	36 x 18	30	31.75 35	3 / 4
YTB 56 108 L	160	36 x 22	30	31.75 35	3 / 4
YTB 56 108 M	160	36 x 28	30	31.75 35	3 / 4
YTB 56 108 N	160	36 x 36	30	31.75 35	3 / 4
YTB 56 108 O	170	45 x 45	30	31.75 35	3 / 4

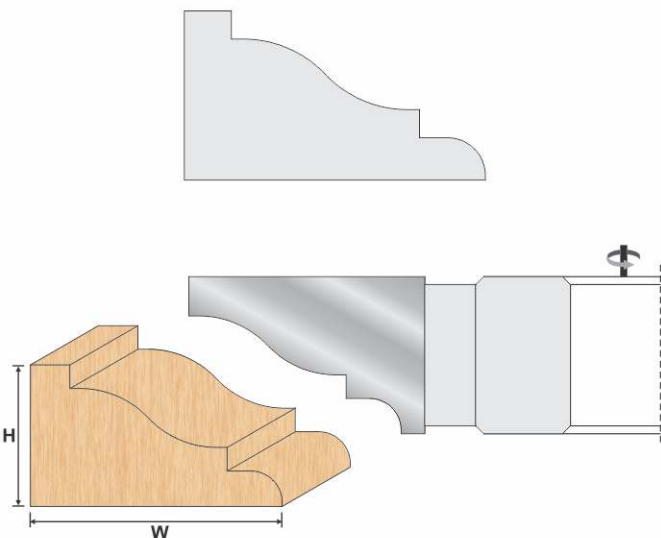

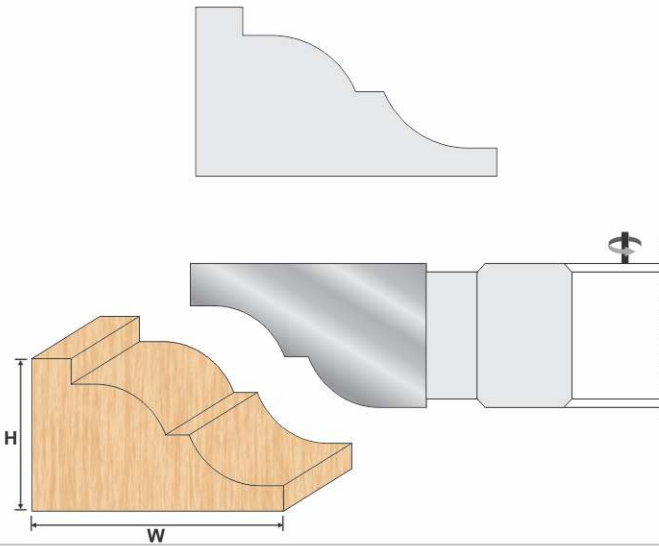

YTB 56

ORDER CODE	DIA	MOULDING SIZE	BORE		TEETH
YTB 56 109 A	125	15 x 15	30	31.75 35	3 / 4
YTB 56 109 B	125	18 x 18	30	31.75 35	3 / 4
YTB 56 109 C	125	20 x 20	30	31.75 35	3 / 4
YTB 56 109 D	125	22 x 22	30	31.75 35	3 / 4
YTB 56 109 E	125	25 x 25	30	31.75 35	3 / 4
YTB 56 109 F	150	28 x 15	30	31.75 35	3 / 4
YTB 56 109 G	150	28 x 28	30	31.75 35	3 / 4
YTB 56 109 H	150	32 x 18	30	31.75 35	3 / 4
YTB 56 109 I	150	32 x 32	30	31.75 35	3 / 4
YTB 56 109 J	160	36 x 15	30	31.75 35	3 / 4
YTB 56 109 K	160	36 x 18	30	31.75 35	3 / 4
YTB 56 109 L	160	36 x 22	30	31.75 35	3 / 4
YTB 56 109 M	160	36 x 28	30	31.75 35	3 / 4
YTB 56 109 N	160	36 x 36	30	31.75 35	3 / 4
YTB 56 109 O	170	45 x 45	30	31.75 35	3 / 4

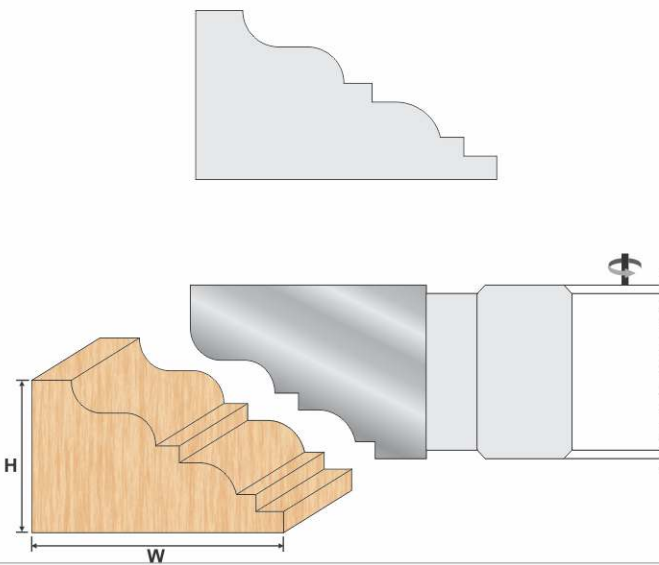

YTB 56

ORDER CODE	DIA	MOULDING SIZE	BORE		TEETH
YTB 56 110 A	125	15 x 15	30	31.75 35	3 / 4
YTB 56 110 B	125	18 x 18	30	31.75 35	3 / 4
YTB 56 110 C	125	20 x 20	30	31.75 35	3 / 4
YTB 56 110 D	125	22 x 22	30	31.75 35	3 / 4
YTB 56 110 E	125	25 x 25	30	31.75 35	3 / 4
YTB 56 110 F	150	28 x 15	30	31.75 35	3 / 4
YTB 56 110 G	150	28 x 28	30	31.75 35	3 / 4
YTB 56 110 H	150	32 x 18	30	31.75 35	3 / 4
YTB 56 110 I	150	32 x 32	30	31.75 35	3 / 4
YTB 56 110 J	160	36 x 15	30	31.75 35	3 / 4
YTB 56 110 K	160	36 x 18	30	31.75 35	3 / 4
YTB 56 110 L	160	36 x 22	30	31.75 35	3 / 4
YTB 56 110 M	160	36 x 28	30	31.75 35	3 / 4
YTB 56 110 N	160	36 x 36	30	31.75 35	3 / 4
YTB 56 110 O	170	45 x 45	30	31.75 35	3 / 4

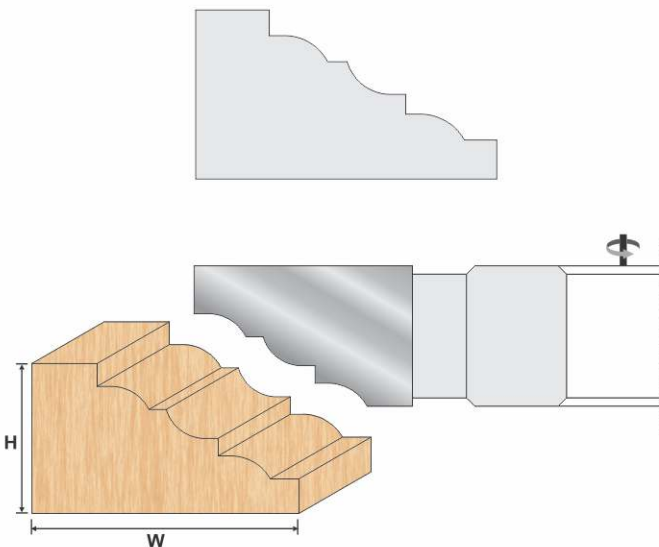

YTB 56

ORDER CODE	DIA	MOULDING SIZE	BORE		TEETH
YTB 56 111 A	125	15 x 15	30	31.75 35	3 / 4
YTB 56 111 B	125	18 x 18	30	31.75 35	3 / 4
YTB 56 111 C	125	20 x 20	30	31.75 35	3 / 4
YTB 56 111 D	125	22 x 22	30	31.75 35	3 / 4
YTB 56 111 E	125	25 x 25	30	31.75 35	3 / 4
YTB 56 111 F	150	28 x 15	30	31.75 35	3 / 4
YTB 56 111 G	150	28 x 28	30	31.75 35	3 / 4
YTB 56 111 H	150	32 x 18	30	31.75 35	3 / 4
YTB 56 111 I	150	32 x 32	30	31.75 35	3 / 4
YTB 56 111 J	160	36 x 15	30	31.75 35	3 / 4
YTB 56 111 K	160	36 x 18	30	31.75 35	3 / 4
YTB 56 111 L	160	36 x 22	30	31.75 35	3 / 4
YTB 56 111 M	160	36 x 28	30	31.75 35	3 / 4
YTB 56 111 N	160	36 x 36	30	31.75 35	3 / 4
YTB 56 111 O	170	45 x 45	30	31.75 35	3 / 4

Cutter Head Set For Railing For Molder Machine T.C.T (Brazed) - YTB 57

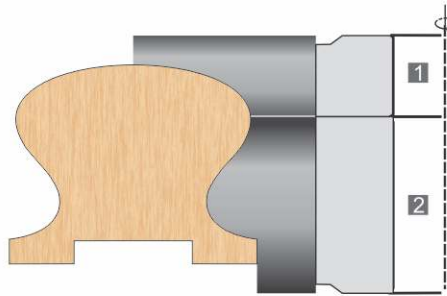
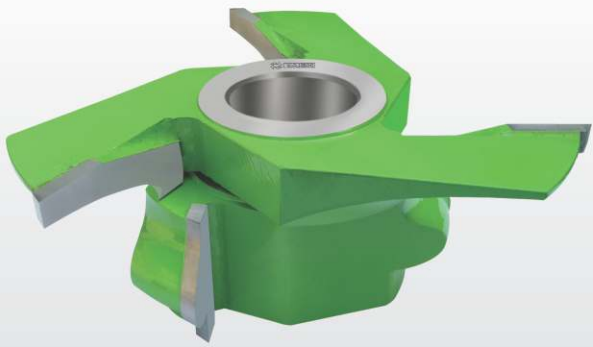

Router Bits



Technical Details :

Use on Spindle Moulder Machines & Moulding machine

Application :

Perfect for solid wood, panel materials & compressed wood

YTB 57

2 PCS. Cutter Set

ORDER CODE	DIA	MOULDING SIZE	BORE		TEETH	
YTB 57 101 A	150	70 x 45	30	31.75	35	3
YTB 57 101 B	150	70 x 60	30	31.75	35	3
YTB 57 101 C	170	90 x 70	30	31.75	35	3

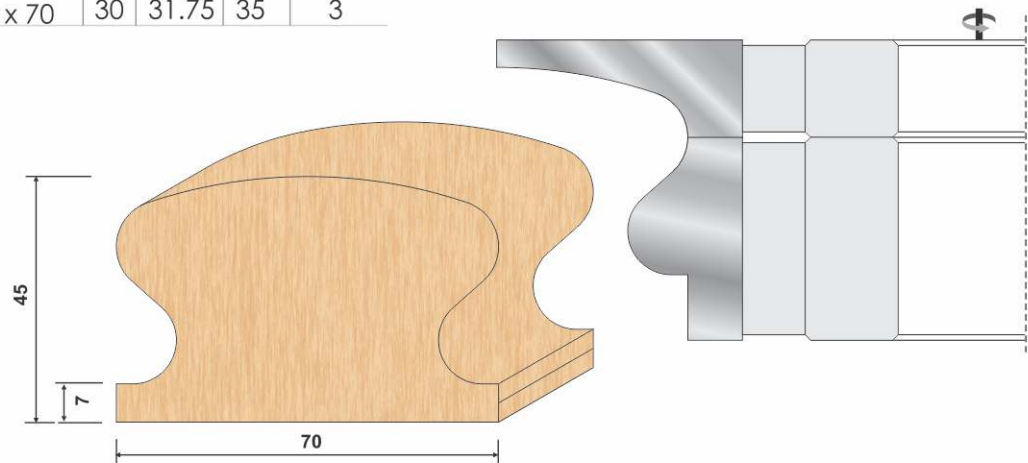

YTB 57

2 PCS. Cutter Set

ORDER CODE	DIA	MOULDING SIZE	BORE		TEETH	
YTB 57 102 A	150	70 x 45	30	31.75	35	3
YTB 57 102 B	150	70 x 60	30	31.75	35	3
YTB 57 102 C	170	90 x 70	30	31.75	35	3

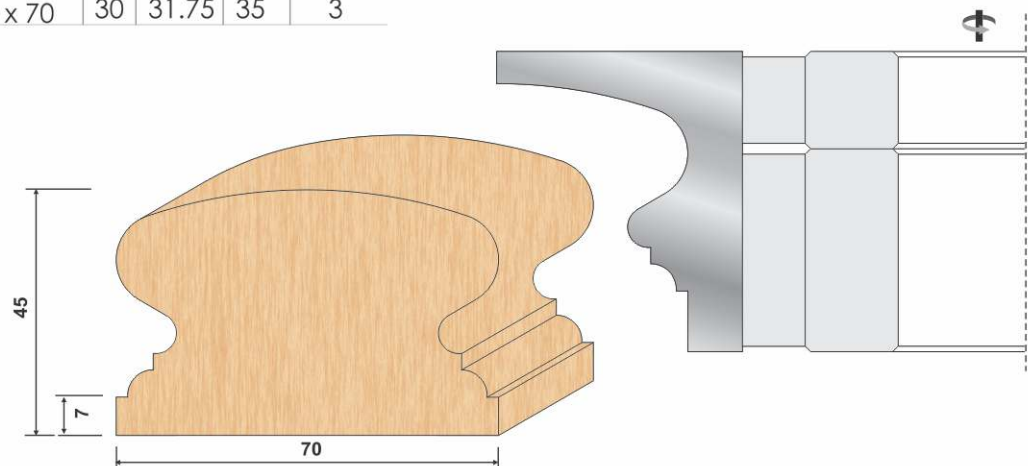

YTB 57

ORDER CODE	DIA	MOULDING SIZE	BORE			TEETH
YTB 57 103 A	150	70 x 45	30	31.75	35	3
YTB 57 103 B	150	70 x 60	30	31.75	35	3
YTB 57 103 C	170	90 x 70	30	31.75	35	3

2 PCS. Cutter Set

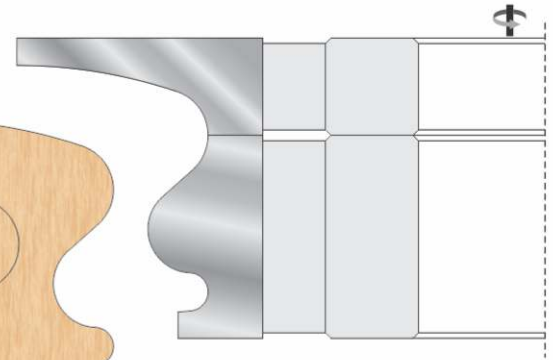
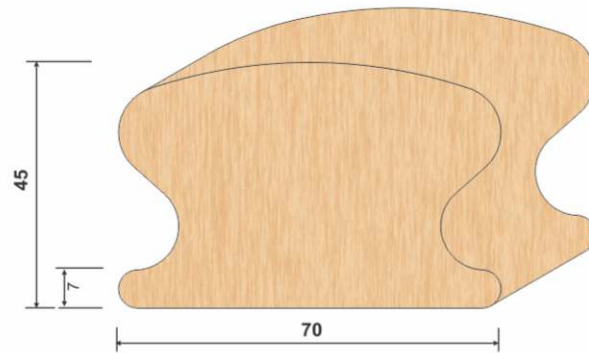

YTB 57

ORDER CODE	DIA	MOULDING SIZE	BORE			TEETH
YTB 57 104 A	150	70 x 45	30	31.75	35	3
YTB 57 104 B	150	70 x 60	30	31.75	35	3
YTB 57 104 C	170	90 x 70	30	31.75	35	3

2 PCS. Cutter Set

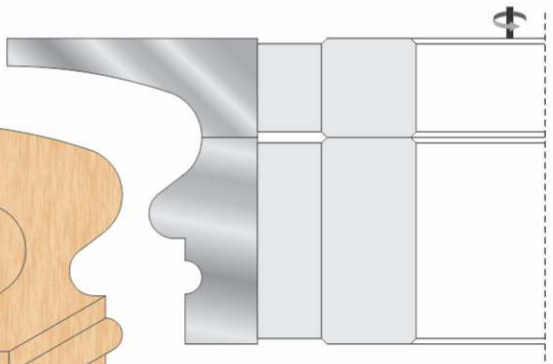
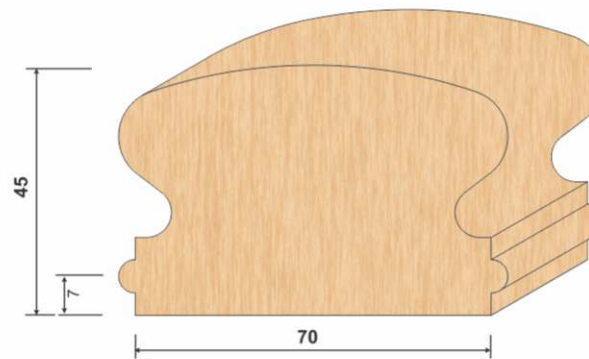

YTB 57

ORDER CODE	DIA	MOULDING SIZE	BORE			TEETH
YTB 57 105 A	150	70 x 45	30	31.75	35	3
YTB 57 105 B	150	70 x 60	30	31.75	35	3
YTB 57 105 C	170	90 x 70	30	31.75	35	3

2 PCS. Cutter Set

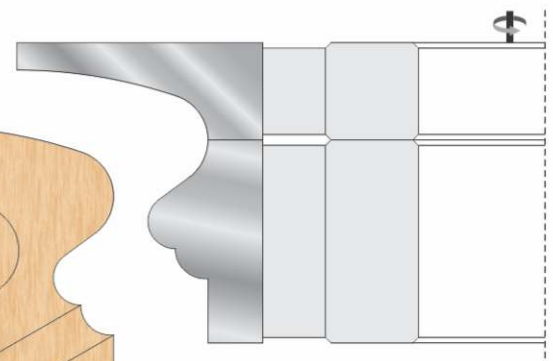
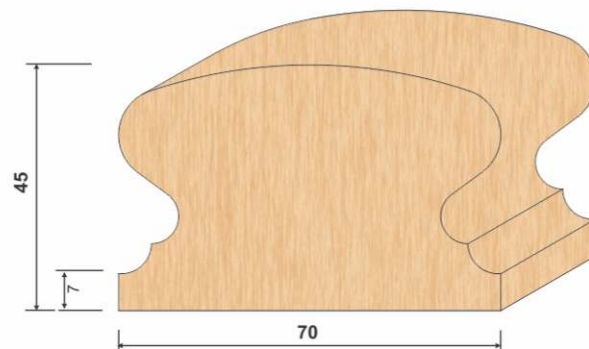

Handle Profile Cutter & Router



Technical Details :
Use on Spindle Moulder Machines

Application :
Used On MDF, Plywood, Partical Board & Solid Wood

Handle Profile Cutter T.C.T (Brazed) - YTB 58

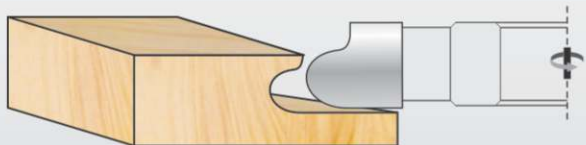
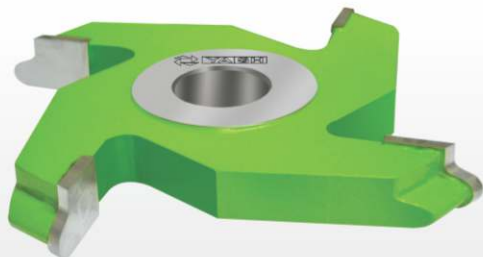

YTB 58						
ORDER CODE	DIA	WOOD THICKNESS	BORE			TEETH
YTB 58 101	150	18mm	30	31.75	35	4
YTB 58 102	150	25mm	30	31.75	35	4
YTB 58 103	150	18mm	30	31.75	35	6
YTB 58 104	150	25mm	30	31.75	35	6

Handle Profile Router Bit T.C.T (Brazed) - YTB 58

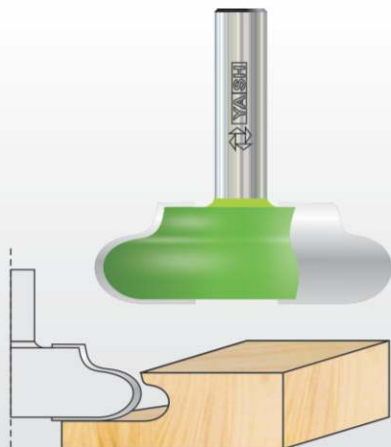

YTB 58				
ORDER CODE	DIA	WOOD THICKNESS	SHANK	TEETH
YTB 58 105	50	16mm	12	2
YTB 58 106	50	18mm	12	2
YTB 58 107	50	25mm	12	2
YTB 58 108	60	16mm	12	2
YTB 58 109	60	18mm	12	2
YTB 58 110	60	25mm	12	2

Handle Profile Cutter T.C.T (Brazed) - YTB 59

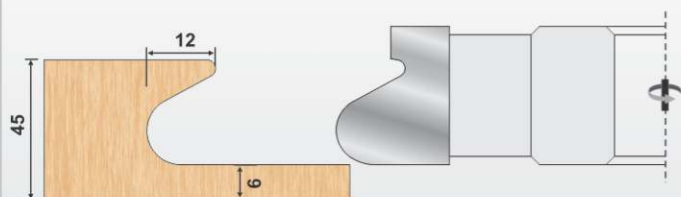

YTB 59						
ORDER CODE	DIA	WOOD THICKNESS	BORE			TEETH
YTB 59 101	150	18mm	30	31.75	35	4
YTB 59 102	150	25mm	30	31.75	35	4
YTB 59 103	150	18mm	30	31.75	35	6
YTB 59 104	150	25mm	30	31.75	35	6

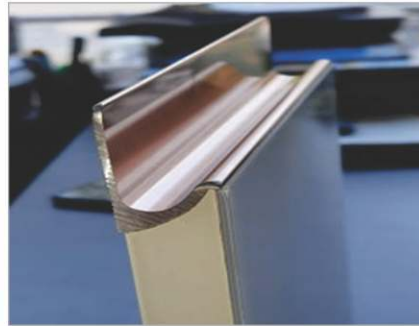
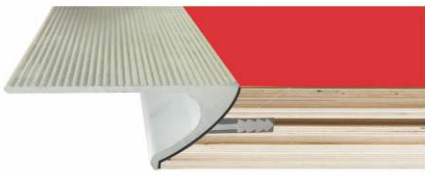

Technical Details :

Use on Spindle Moulder Machines

Application :

Used On MDF, Plywood, Partical Board & Solid Wood

J Profile Cutter T.C.T (Brazed) - YTB 60



YTB 60

ORDER CODE	DIA	WOOD THICKNESS	BORE			TEETH
YTB 60 101	125	18mm/ 23 R	30	31.75	35	4

J Profile Router Bit With Bearing T.C.T (Brazed) - YTB 60

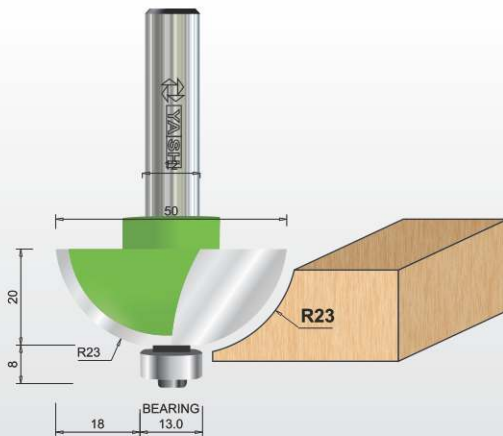

USED ON ROUTER MACHINE

YTB 60

ORDER CODE	DIA	WOOD THICKNESS	SHANK	TEETH
YTB 60 102	50	18mm/ 23 R	12	2

J Profile Router bit Without Bearing T.C.T (Brazed) - YTB 60

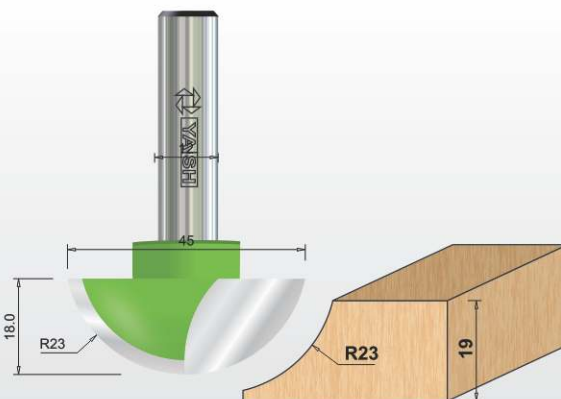

USED ON ROUTER MACHINE

YTB 60

ORDER CODE	DIA	WOOD THICKNESS	SHANK	TEETH
YTB 60 103	50	18mm/ 23 R	12	2

Handle Profile Router Bit T.C.T (Brazed) - YTB 61

USED ON ROUTER MACHINE

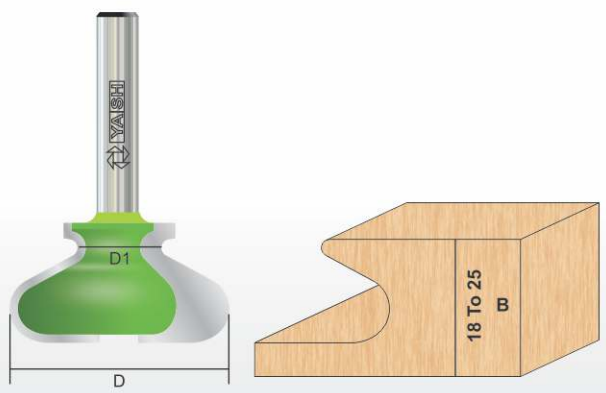

YTB 61					
ORDER CODE	DIA	WOOD THICKNESS(B)	D1	SHANK	TEETH
YTB 61 101	35	16mm	15	12	2
YTB 61 102	35	18mm	15	12	2
YTB 61 103	35	25mm	15	12	2
YTB 61 104	40	16mm	20	12	2
YTB 61 105	40	18mm	20	12	2
YTB 61 106	40	25mm	20	12	2
YTB 61 107	45	16mm	25	12	2
YTB 61 108	45	18mm	25	12	2
YTB 61 109	45	25mm	25	12	2
YTB 61 110	50	16mm	30	12	2
YTB 61 111	50	18mm	30	12	2
YTB 61 112	50	25mm	30	12	2

Application :
Used On MDF, Plywood, Partical Board & Solid Wood

Handle Profile Router Bit T.C.T (Brazed) - YTB 62 (2pcs Set)

USED ON ROUTER MACHINE

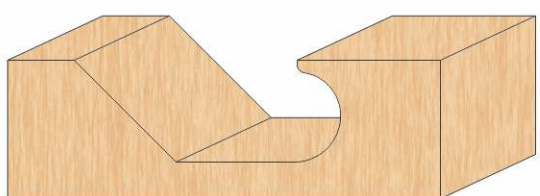
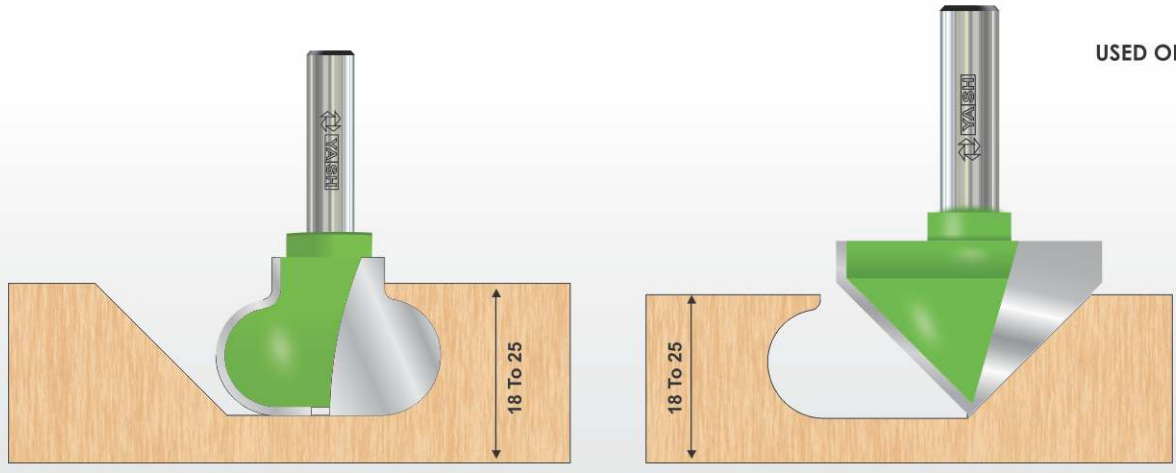

YTB 62				
ORDER CODE	DIA	WOOD THICKNESS	SHANK	TEETH
YTB 62 101	26 / 34	18mm	12	2
YTB 62 102	26 / 34	25mm	12	2

Handle Profile Router Bit T.C.T (Brazed) - YTB 63 (2pcs Set)

USED ON ROUTER MACHINE

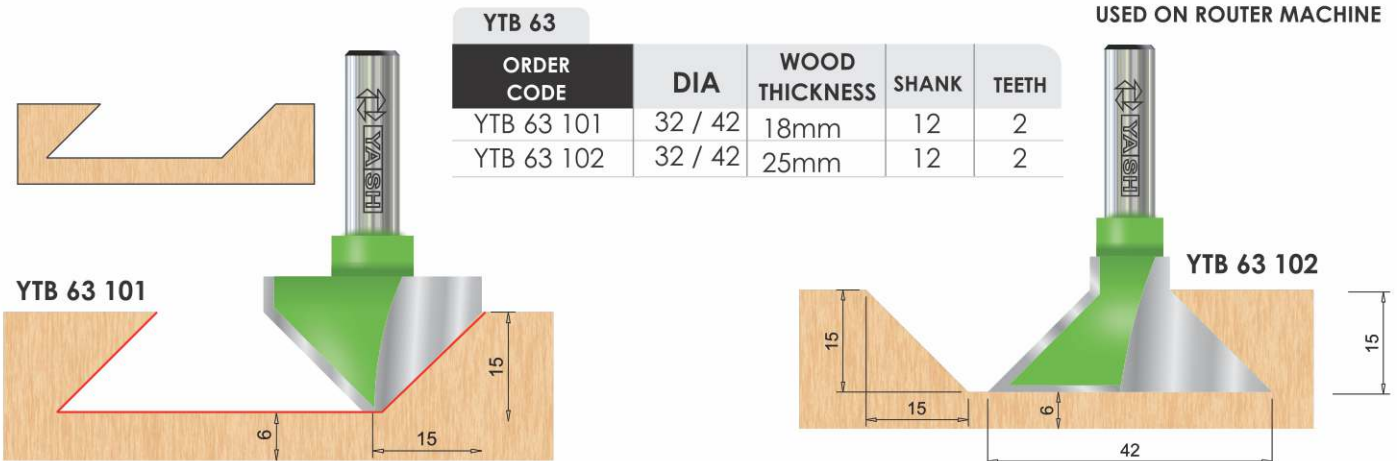

YTB 63				
ORDER CODE	DIA	WOOD THICKNESS	SHANK	TEETH
YTB 63 101	32 / 42	18mm	12	2
YTB 63 102	32 / 42	25mm	12	2

Any Customized Specifications Also Can Make As Per Requirements

Technical Details :

Use on Spindle Moulder Machines

Application :

Solid Wood , MDF, Particle Board & Ply Wood

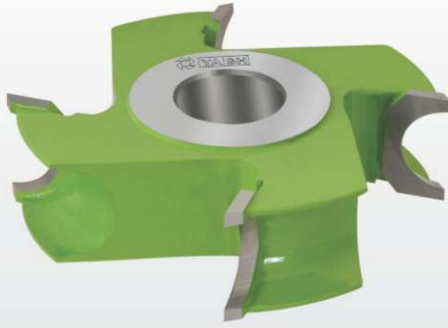

YTB 64

ORDER CODE	DIA	WOOD THICKNESS	BORE			TEETH
YTB 64 101	125	12mm / 6 R	30	31.75	35	4
YTB 64 102	125	15mm / 7.5 R	30	31.75	35	4
YTB 64 103	125	16mm / 8 R	30	31.75	35	4
YTB 64 104	125	18mm / 9 R	30	31.75	35	4
YTB 64 105	125	20mm / 10 R	30	31.75	35	4
YTB 64 106	125	25mm / 12.5 R	30	31.75	35	4
YTB 64 107	125	30mm / 15 R	30	31.75	35	4
YTB 64 108	125	32mm / 16 R	30	31.75	35	4
YTB 64 109	125	35mm / 17.5 R	30	31.75	35	4
YTB 64 110	125	36mm / 18 R	30	31.75	35	4
YTB 64 111	125	38mm / 19 R	30	31.75	35	4
YTB 64 112	125	40mm / 20 R	30	31.75	35	4
YTB 64 113	125	45mm / 22.5 R	30	31.75	35	4
YTB 64 114	150	50mm / 25 R	30	31.75	35	4
YTB 64 115	150	60mm / 30 R	30	31.75	35	4

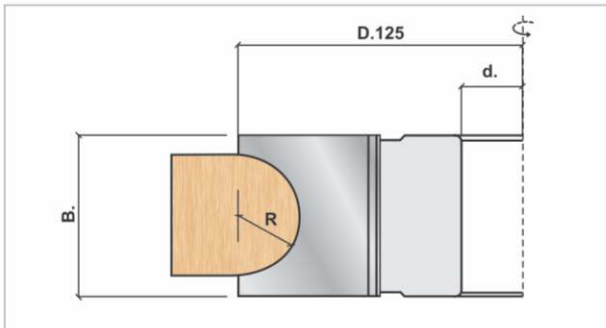

Quarter Radius Cutter T.C.T (Brazed) - YTB 65

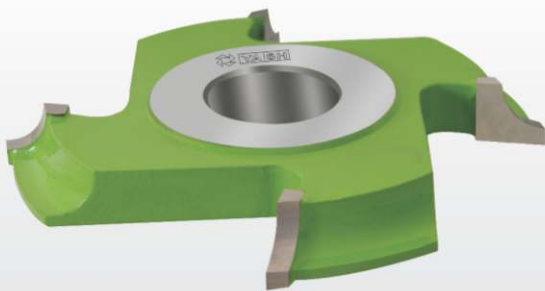

YTB 65

ORDER CODE	DIA	WOOD THICKNESS	BORE			TEETH
YTB 65 101	125	4 R	30	31.75	35	4
YTB 65 102	125	6 R	30	31.75	35	4
YTB 65 103	125	8 R	30	31.75	35	4
YTB 65 104	125	9 R	30	31.75	35	4
YTB 65 105	125	10 R	30	31.75	35	4
YTB 65 106	125	12.5 R	30	31.75	35	4
YTB 65 107	125	15 R	30	31.75	35	4
YTB 65 108	125	18 R	30	31.75	35	4
YTB 65 109	125	22 R	30	31.75	35	4
YTB 65 110	125	25 R	30	31.75	35	4
YTB 65 111	125	30 R	30	31.75	35	4
YTB 65 112	125	32 R	30	31.75	35	4
YTB 65 113	125	35 R	30	31.75	35	4
YTB 65 114	150	40 R	30	31.75	35	4
YTB 65 115	175	50 R	30	31.75	35	4
YTB 65 116	200	60 R	30	31.75	35	4

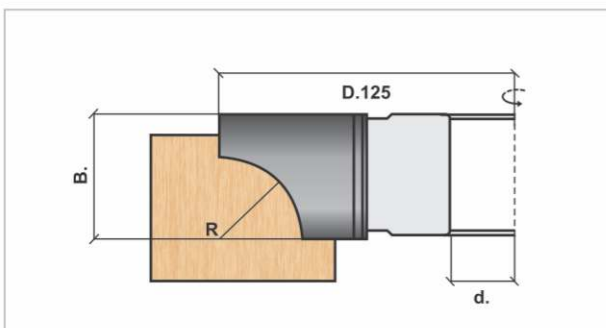

Edge Rounding Cutter T.C.T (Brazed) - YTB 66



Technical Details :

Use on Spindle Moulder Machines

Application :

Solid Wood , MDF, Particle Board & Ply Wood

YTB 66

ORDER CODE	DIA	WOOD THICKNESS	BORE			TEETH
YTB 66 101	125	18mm / 4 R	30	31.75	35	4
YTB 66 102	125	25mm / 4 R	30	31.75	35	4
YTB 66 103	125	25mm / 6 R	30	31.75	35	4
YTB 66 104	125	35mm / 6 R	30	31.75	35	4
YTB 66 105	125	35mm / 9 R	30	31.75	35	4

Table Top Bull Nose Cutter T.C.T (Brazed) - YTB 67

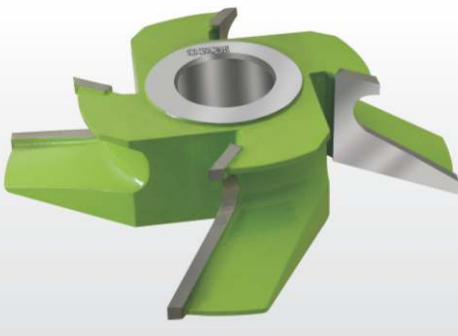

Bull Nose



YTB 67

Bull Nose

ORDER CODE	DIA	WOOD THICKNESS	BORE			TEETH
YTB 67 101	150	18mm	30	31.75	35	4
YTB 67 102	150	25mm	30	31.75	35	4
YTB 67 103	150	35mm	30	31.75	35	4
YTB 67 104	150	50mm	30	31.75	35	4

Duck Nose



YTB 67

Duck Nose

ORDER CODE	DIA	WOOD THICKNESS	BORE			TEETH
YTB 67 105	150	18mm	30	31.75	35	4
YTB 67 106	150	25mm	30	31.75	35	4
YTB 67 107	150	35mm	30	31.75	35	4
YTB 67 108	150	50mm	30	31.75	35	4

Adjustable Lock Drawer Cutter T.C.T (Brazed) - YTB 68



Technical Details :

Use on Spindle Moulder Machines

Application :

Solid Wood , MDF, Particle Board & Ply Wood

YTB 68

ORDER CODE	DIA	WOOD THICKNESS	BORE			TEETH
YTB 68 101	125	4mm	30	31.75	35	6
YTB 68 102	125	6mm	30	31.75	35	6
YTB 68 103	125	8mm	30	31.75	35	6
YTB 68 104	125	10mm	30	31.75	35	6
YTB 68 105	125	12mm	30	31.75	35	6



Technical Details :

Use on Spindle Moulder, Four Side Moulder machine

Application :

Solid Wood, MDF Board & practical board

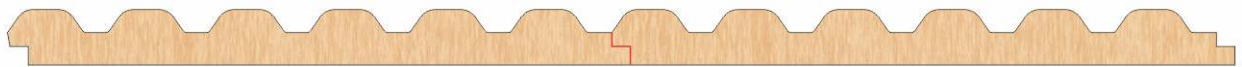
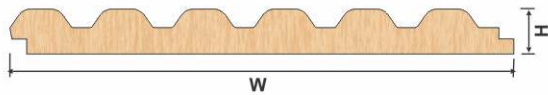
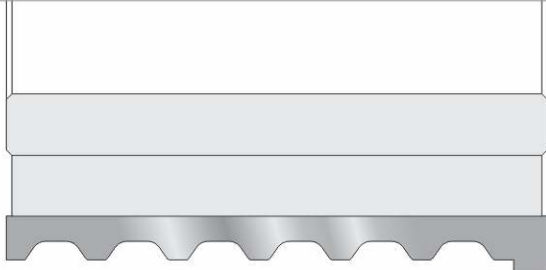

YTB 69

ORDER CODE	DIA	WIDTH	BORE			TEETH
YTB 69 101	125	100mm	30	31.75	35	4
YTB 69 102	125	115mm	30	31.75	35	4
YTB 69 103	125	130mm	30	31.75	35	4

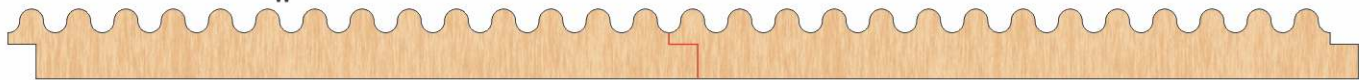
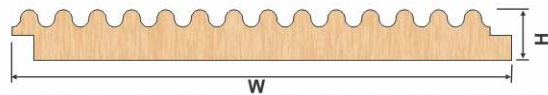
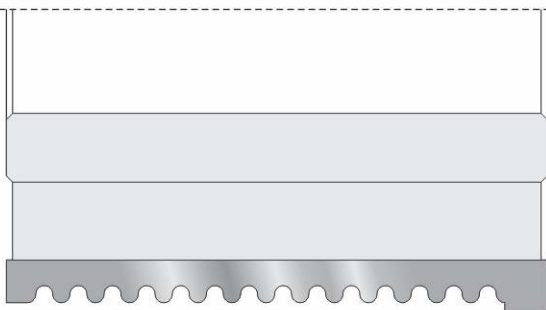

YTB 69

ORDER CODE	DIA	WIDTH	BORE			TEETH
YTB 69 104	125	100mm	30	31.75	35	4
YTB 69 105	125	115mm	30	31.75	35	4
YTB 69 106	125	130mm	30	31.75	35	4

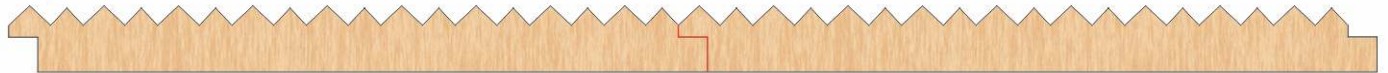
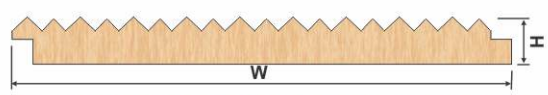

YTB 69

ORDER CODE	DIA	WIDTH	BORE			TEETH
YTB 69 107	125	100mm	30	31.75	35	4
YTB 69 108	125	115mm	30	31.75	35	4
YTB 69 109	125	130mm	30	31.75	35	4

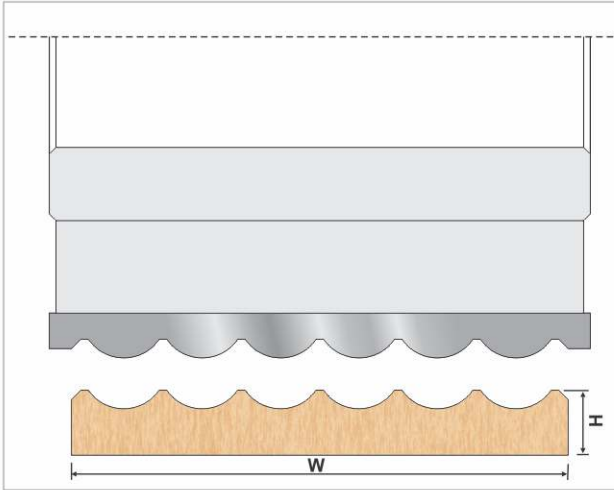

YTB 69

ORDER CODE	DIA	WIDTH	BORE			TEETH
YTB 69 110	125	100mm	30	31.75	35	4
YTB 69 111	125	115mm	30	31.75	35	4
YTB 69 112	125	130mm	30	31.75	35	4

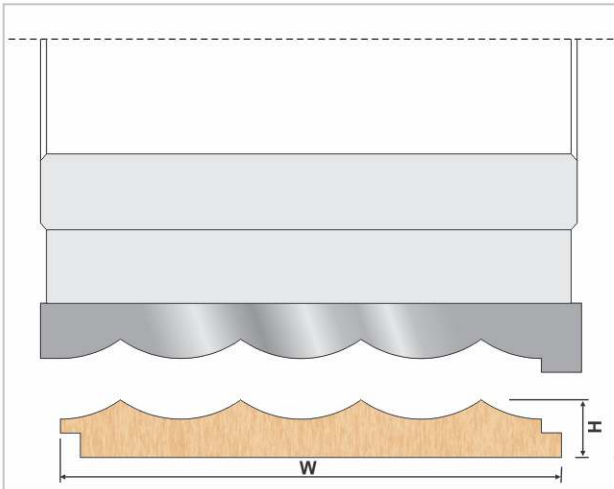

YTB 69

ORDER CODE	DIA	WIDTH	BORE			TEETH
YTB 69 113	125	100mm	30	31.75	35	4
YTB 69 114	125	115mm	30	31.75	35	4
YTB 69 115	125	130mm	30	31.75	35	4

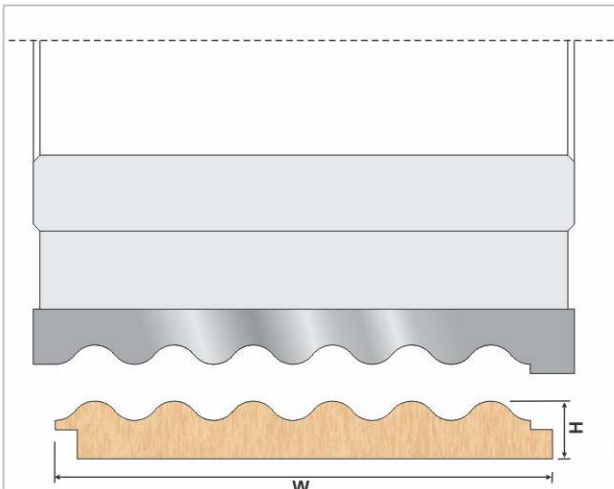

YTB 69

ORDER CODE	DIA	WIDTH	BORE			TEETH
YTB 69 116	125	100mm	30	31.75	35	4
YTB 69 117	125	115mm	30	31.75	35	4
YTB 69 118	125	130mm	30	31.75	35	4

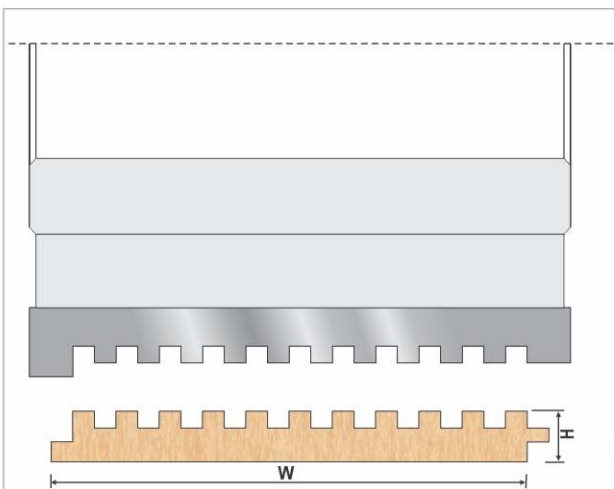

YTB 69

ORDER CODE	DIA	WIDTH	BORE			TEETH
YTB 69 119	125	100mm	30	31.75	35	4
YTB 69 120	125	115mm	30	31.75	35	4
YTB 69 121	125	130mm	30	31.75	35	4

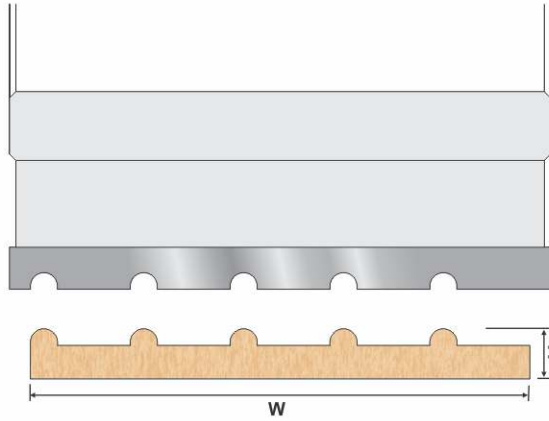

YTB 69

ORDER CODE	DIA	WIDTH	BORE			TEETH
YTB 69 122	125	100mm	30	31.75	35	4
YTB 69 123	125	115mm	30	31.75	35	4
YTB 69 124	125	130mm	30	31.75	35	4

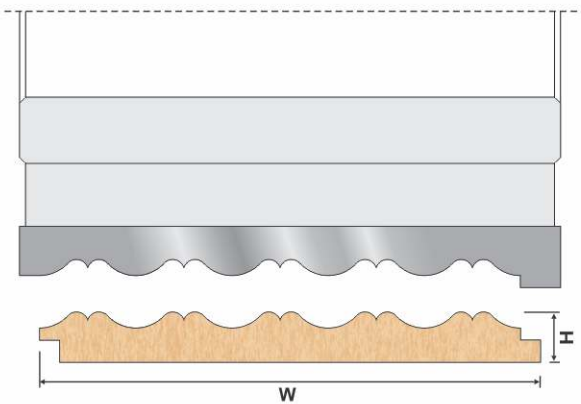
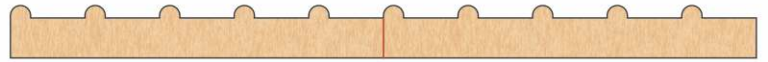

YTB 69

ORDER CODE	DIA	WIDTH	BORE			TEETH
YTB 69 125	125	100mm	30	31.75	35	4
YTB 69 126	125	115mm	30	31.75	35	4
YTB 69 127	125	130mm	30	31.75	35	4

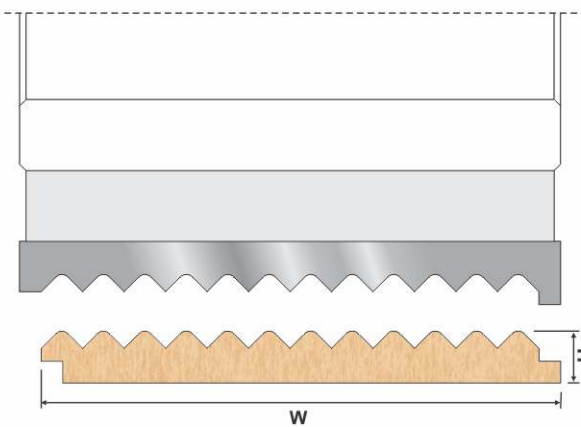
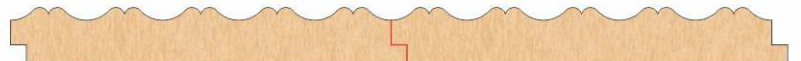

YTB 69

ORDER CODE	DIA	WIDTH	BORE			TEETH
YTB 69 128	125	100mm	30	31.75	35	4
YTB 69 129	125	115mm	30	31.75	35	4
YTB 69 130	125	130mm	30	31.75	35	4

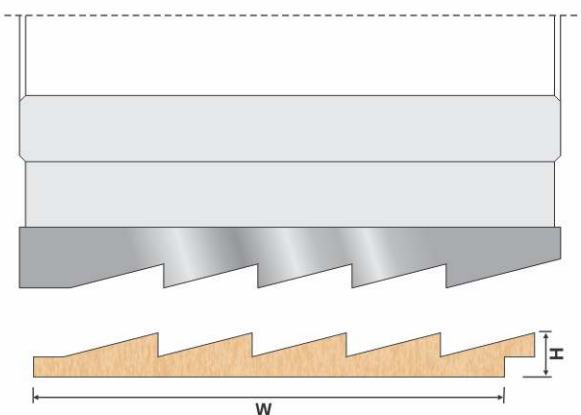

YTB 69

ORDER CODE	DIA	WIDTH	BORE			TEETH
YTB 69 131	125	100mm	30	31.75	35	4
YTB 69 132	125	115mm	30	31.75	35	4
YTB 69 133	125	130mm	30	31.75	35	4



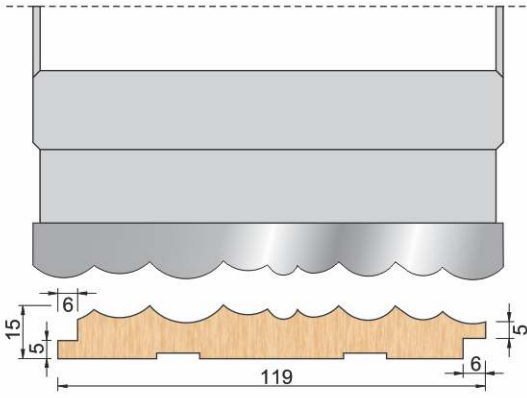

YTB 69

ORDER CODE	DIA	WIDTH	BORE			TEETH
YTB 69 134	125	100mm	30	31.75	35	4
YTB 69 135	125	115mm	30	31.75	35	4
YTB 69 136	125	130mm	30	31.75	35	4

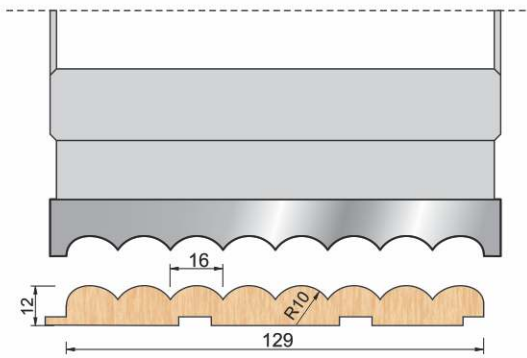
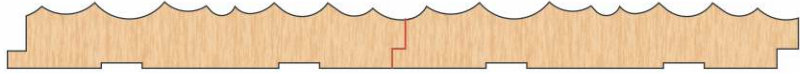

YTB 69

ORDER CODE	DIA	WIDTH	BORE			TEETH
YTB 69 137	125	100mm	30	31.75	35	4
YTB 69 138	125	115mm	30	31.75	35	4
YTB 69 139	125	130mm	30	31.75	35	4

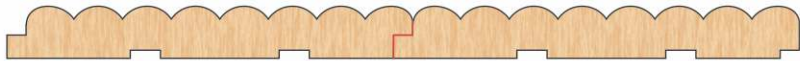

Paneling For Wall Design Cutter T.C.T (Brazed) - YTB 70

Adjustable
Paneling For Wall Design Cutter

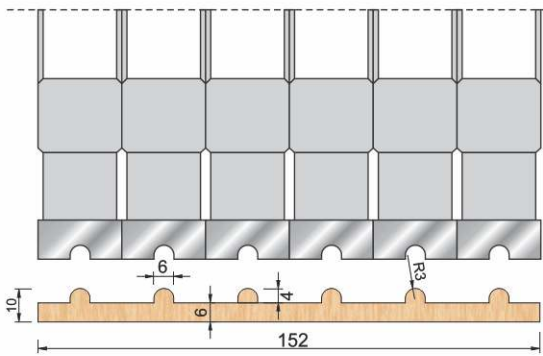

YTB 70

ORDER CODE	DIA	WIDTH	BORE			TEETH
YTB 70 101	125	100mm	30	31.75	35	4
YTB 70 102	125	115mm	30	31.75	35	4
YTB 70 103	125	130mm	30	31.75	35	4

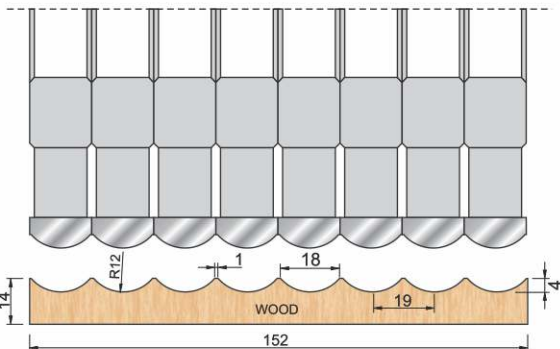
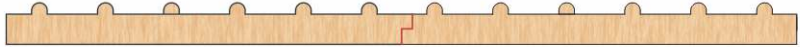

YTB 70

ORDER CODE	DIA	WIDTH	BORE			TEETH
YTB 70 104	125	100mm	30	31.75	35	4
YTB 70 105	125	115mm	30	31.75	35	4
YTB 70 106	125	130mm	30	31.75	35	4

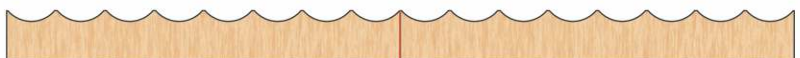

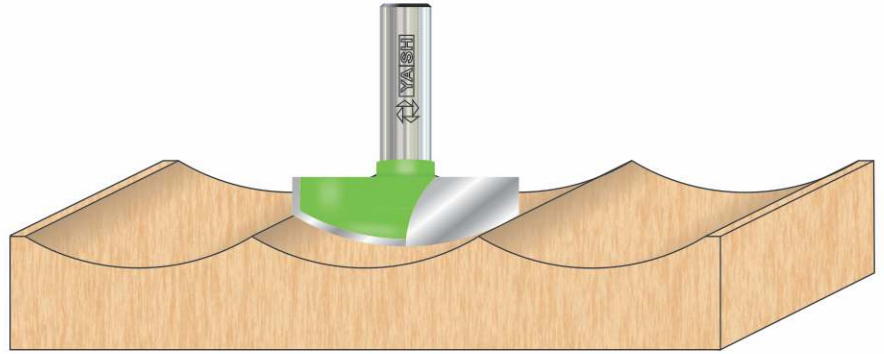

Technical Details :

Use on CNC Router Machine

Application :

Solid Wood, MDF Board & practical board

SHANK : 8mm & 12mm

YTB 71-101

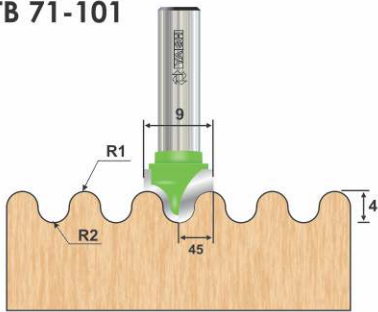

YTB 71-102

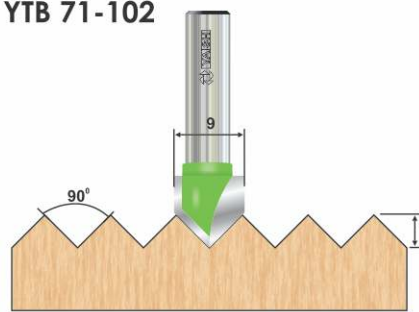

YTB 71-103

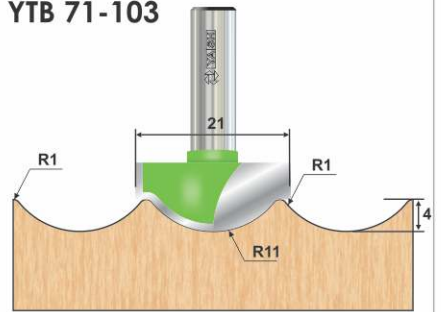

YTB 71-104

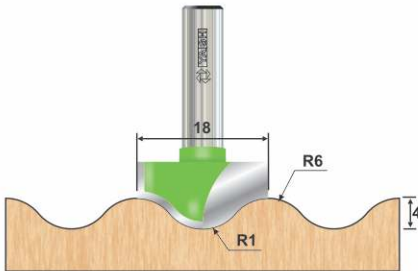

YTB 71-105

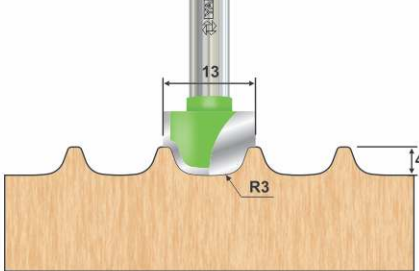

YTB 71-106

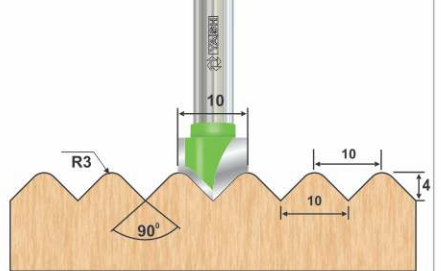

YTB 71-107

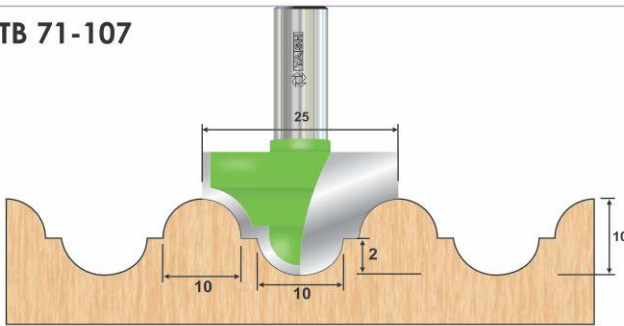

YTB 71-108

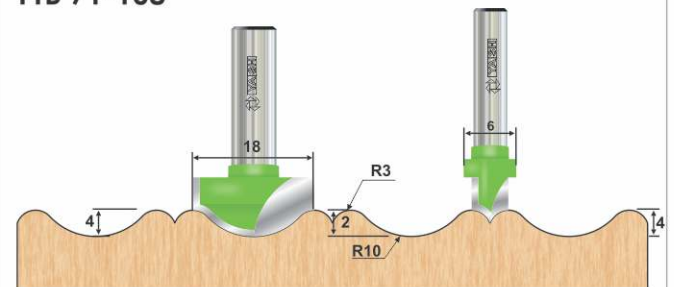

YTB 71-109

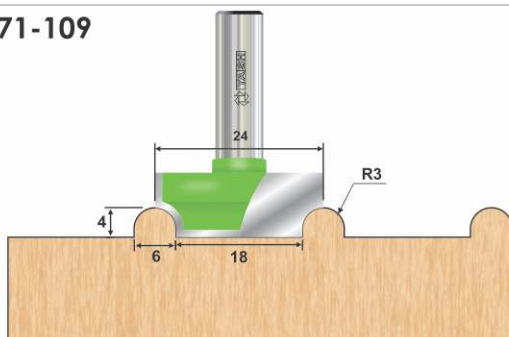

YTB 71-110

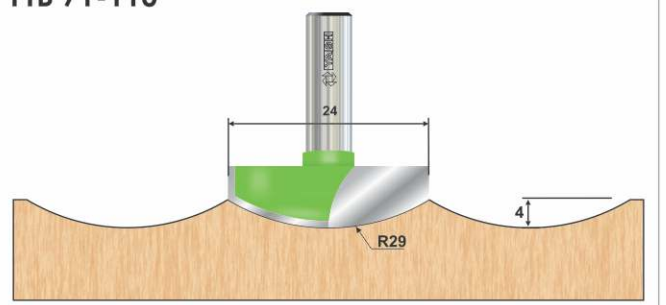

Any Customized Specifications Also Can Make As Per Requirements

Making Pencil Cutter T.C.T (Brazed) - YTB 72



Technical Details :
Use on Four Side moulder machine

Application :
solid wood

Making Pencil Cutter T.C.T (Brazed) - YTB 72

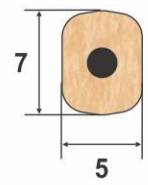
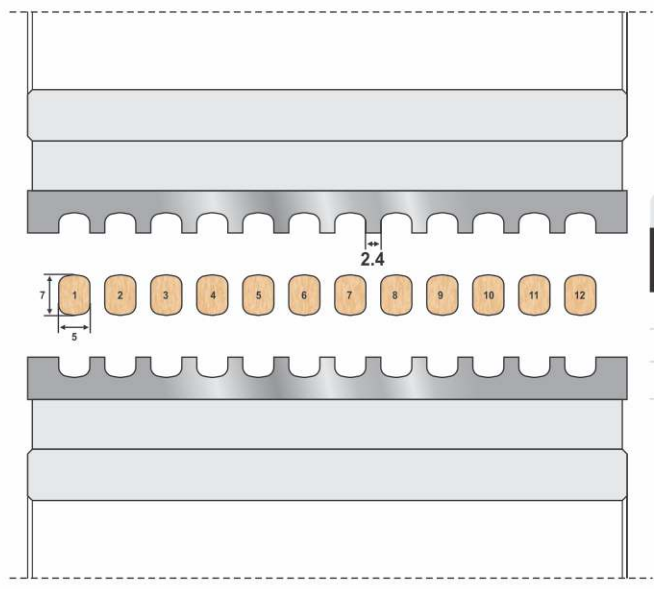

YTB 72					
ORDER CODE	DIA	STICK SIZE	STICK PCS	BORE	TEETH
YTB 72 101	125	5 x 7	4	40	6
YTB 72 102	125	5 x 7	8	40	6
YTB 72 103	125	5 x 7	12	40	6

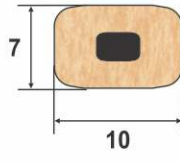
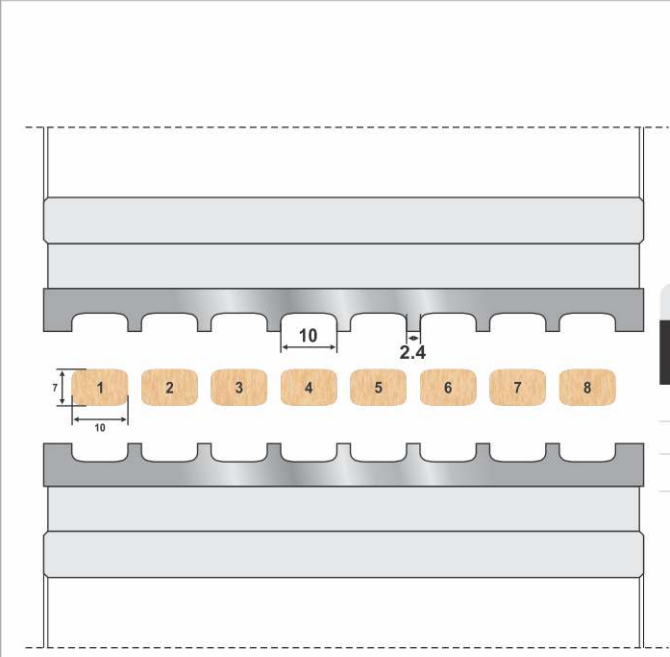

YTB 72					
ORDER CODE	DIA	STICK SIZE	STICK PCS	BORE	TEETH
YTB 72 104	125	10 x 7	3	40	6
YTB 72 105	125	10 x 7	6	40	6
YTB 72 106	125	10 x 7	8	40	6

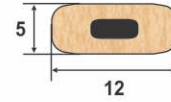
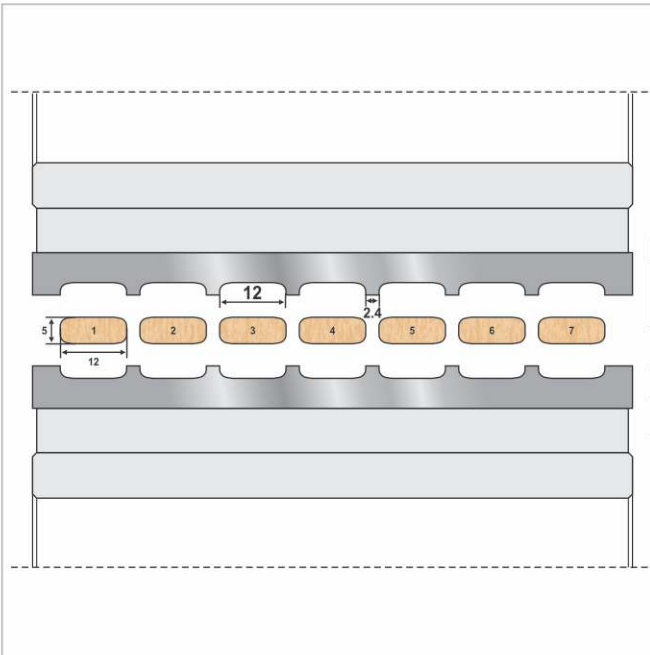

YTB 72

ORDER CODE	DIA	STICK SIZE	STICK PCS	BORE	TEETH
YTB 72 107	125	12 x 5	4	40	6
YTB 72 108	125	12 x 5	6	40	6
YTB 72 109	125	12 x 5	8	40	6

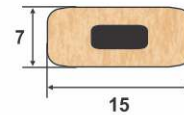
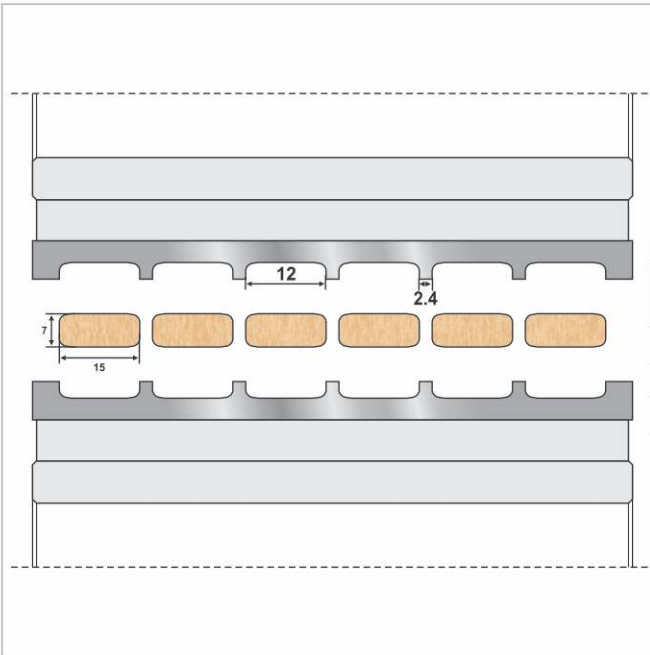

YTB 72

ORDER CODE	DIA	STICK SIZE	STICK PCS	BORE	TEETH
YTB 72 110	125	15 x 7	2	40	6
YTB 72 111	125	15 x 7	4	40	6
YTB 72 112	125	15 x 7	6	40	6

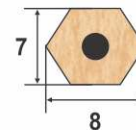
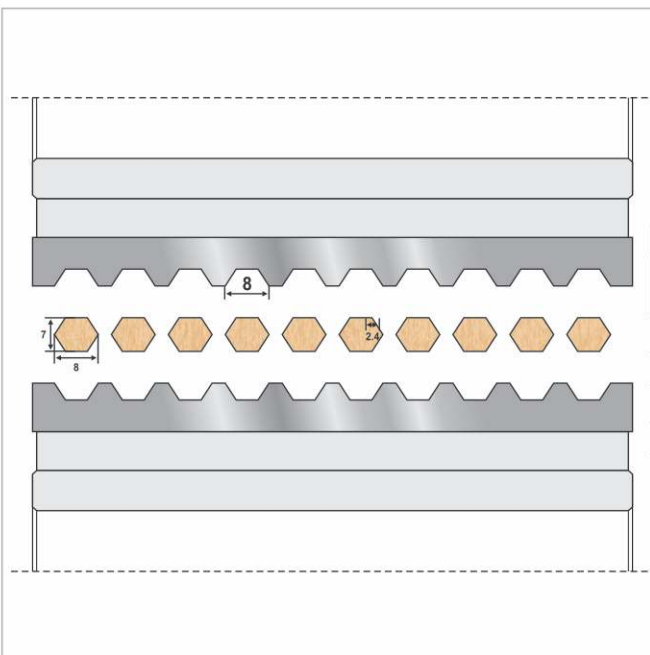

YTB 72

ORDER CODE	DIA	STICK SIZE	STICK PCS	BORE	TEETH
YTB 72 113	125	7 x 8	4	40	6
YTB 72 114	125	7 x 8	6	40	6
YTB 72 115	125	7 x 8	8	40	6
YTB 72 116	125	7 x 8	10	40	6

Wooden Tabel Leg Making Cutter T.C.T (Brazed) - YTB 73 (30 Pcs Set)

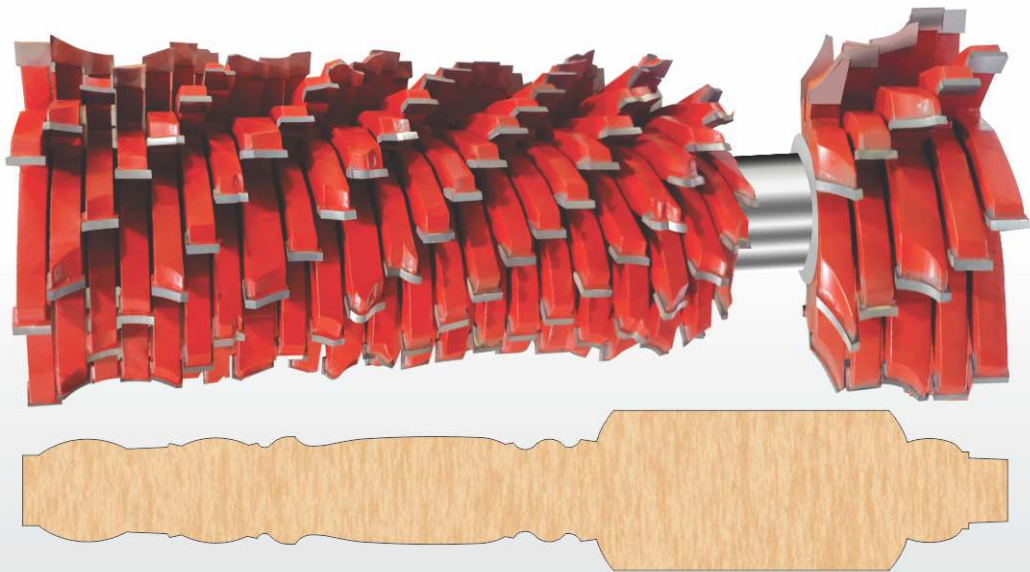

Cutter Set For Wooden Table Legs Every Project Enjoy countless memories around the perfect table. Dining and Furniture legs from Timber Wolf are as per your design and size, ideal for you next table build. Available in a variety of wood species and styles , these versatile table legs arrive unfinished to your door. Sanded and project ready, furniture legs are a great way to add incredible value to the home.

LEG MANUFACTURING MACHINE & CUTTERS by

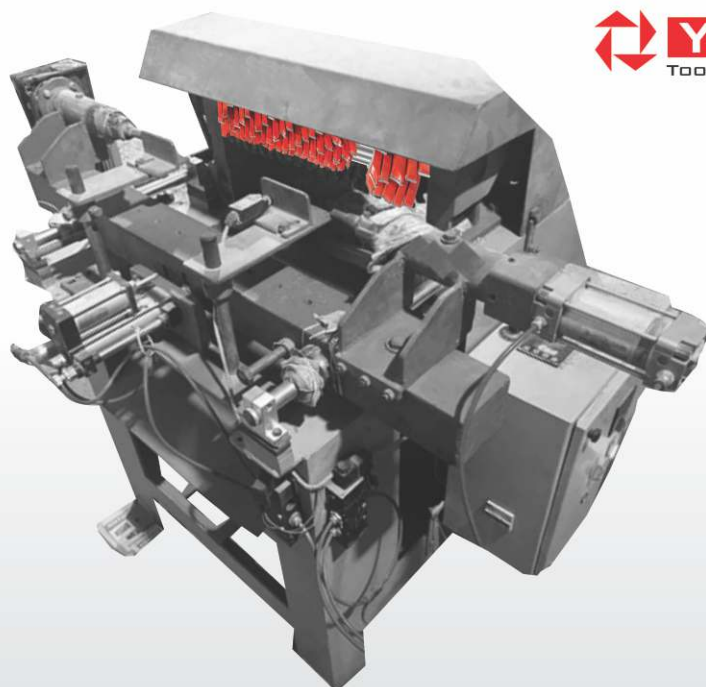

30 Pcs Set



Wooden Tabel Leg Making Cutter T.C.T (Brazed) - YTB 73 (30 Pcs Set)

YTB 73

ORDER CODE	DIA	WOODEN LENGTH	BORE	TEETH
YTB 73 101	190	614 mm	40	8

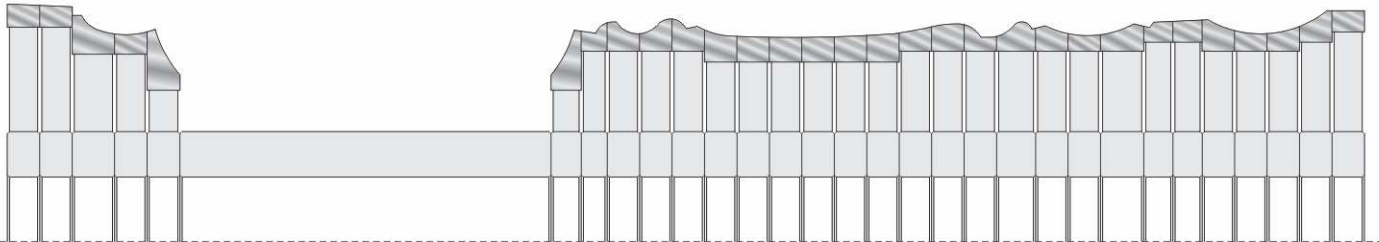
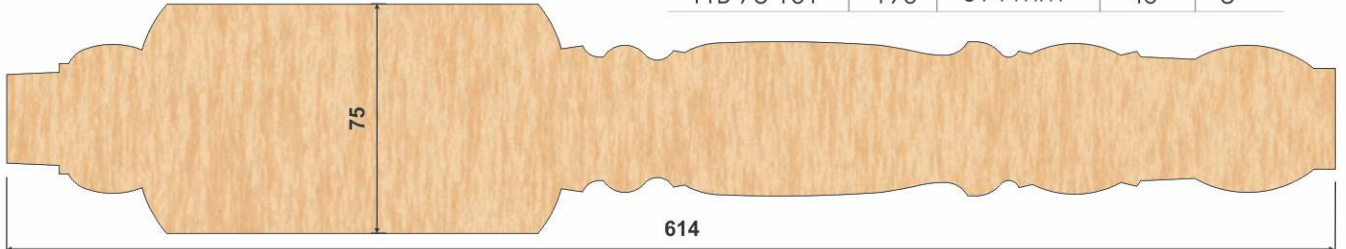

Wooden Tabel Leg Making Cutter T.C.T (Brazed) - YTB 73 (23 Pcs Set)

YTB 73

ORDER CODE	DIA	WOODEN LENGTH	BORE	TEETH
YTB 73 102	190	614 mm	40	8

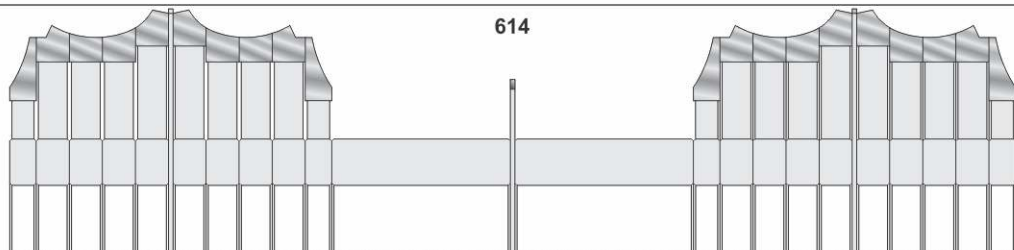
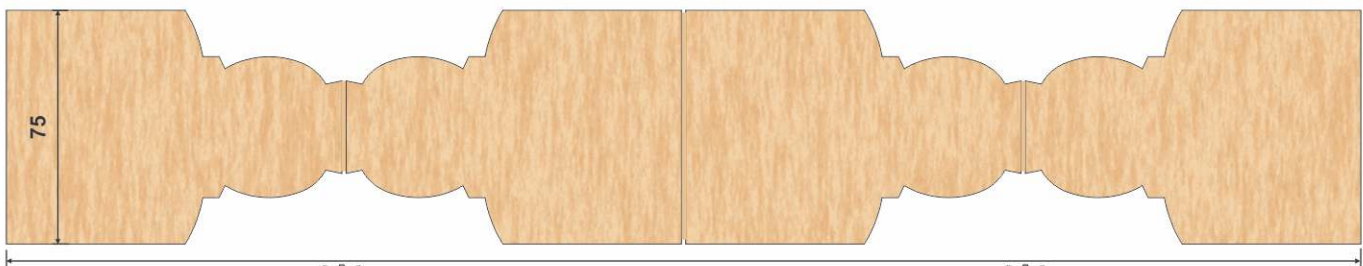

Wooden Tabel Leg Making Cutter T.C.T (Brazed) - YTB 73 (12 Pcs Set)

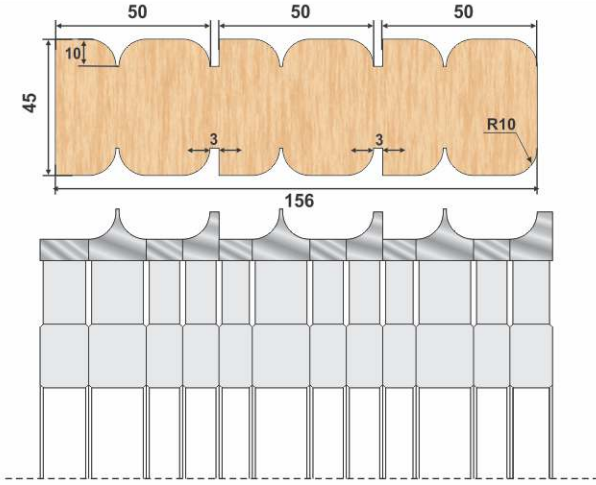

YTB 73

ORDER CODE	DIA	WOODEN LENGTH	BORE	TEETH
YTB 73 103	175	160 mm	40	8

Wooden Tabel Leg Making Cutter T.C.T (Brazed) - YTB 73 (7 Pcs Set)

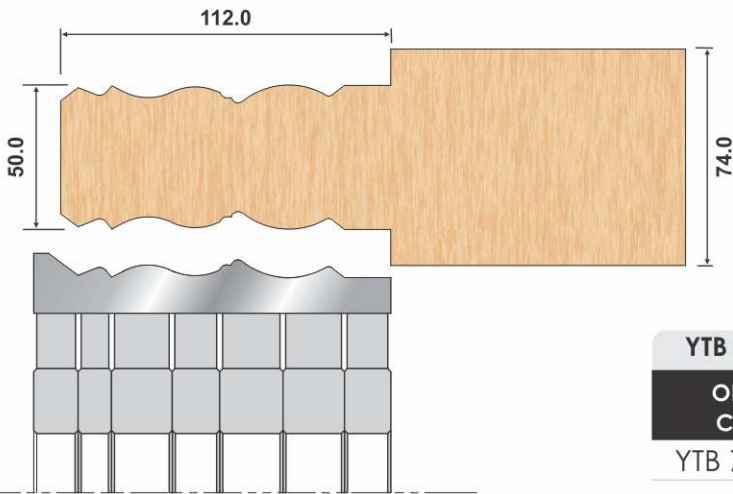

YTB 73

ORDER CODE	DIA	WOODEN LENGTH	BORE	TEETH
YTB 73 104	190	115mm	40	8

Belan Rolling Pin Making Cutter T.C.T (Brazed) - YTB 73 (40 Pcs Set)

YTB 73

ORDER CODE	DIA	WOODEN LENGTH	BORE	TEETH
YTB 73 105	190	455 mm	40	8

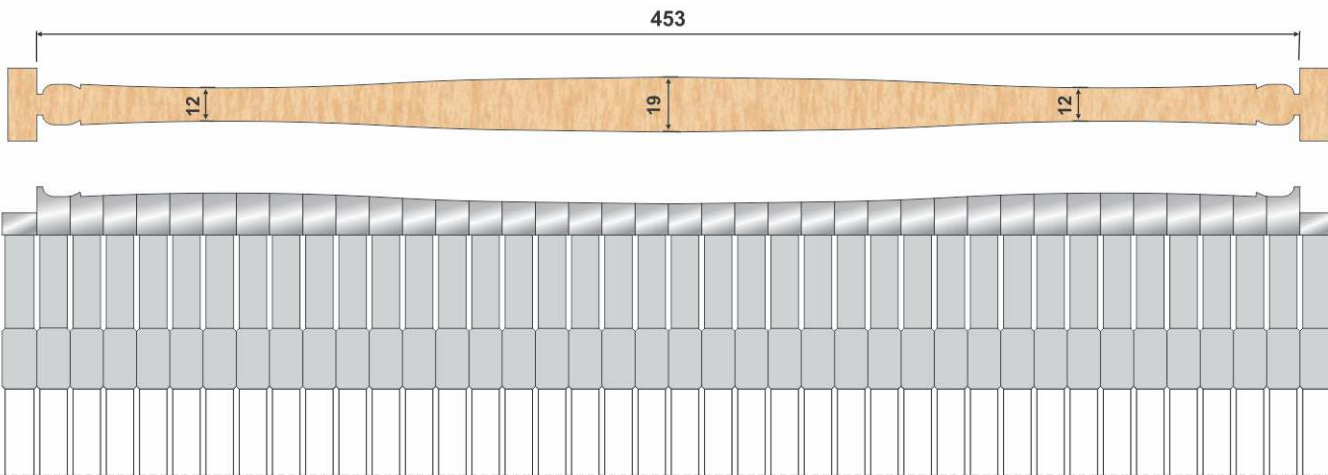

Belan Rolling Pin Making Cutter T.C.T (Brazed) - YTB 73 (30 Pcs Set)

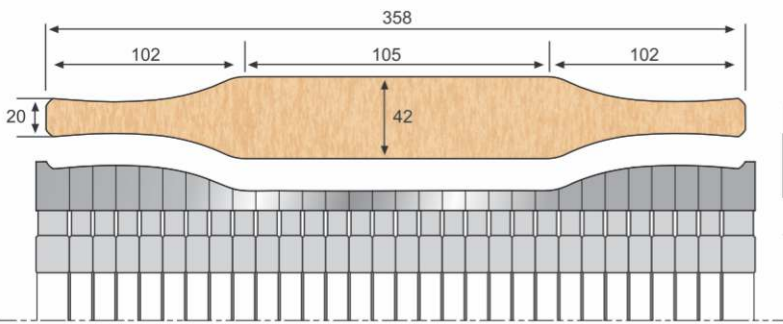

YTB 73

ORDER CODE	DIA	WOODEN LENGTH	BORE	TEETH
YTB 73 106	190	360 mm	40	8

Belan Rolling Pin Making Cutter T.C.T (Brazed) - YTB 73 (30 Pcs Set)

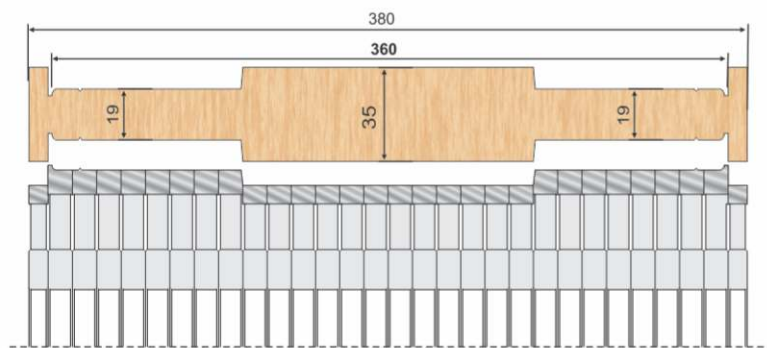

YTB 73

ORDER CODE	DIA	WOODEN LENGTH	BORE	TEETH
YTB 73 107	190	380 mm	40	8

Handel Profile Making Cutter T.C.T (Brazed) - YTB 73 (10 Pcs Set)

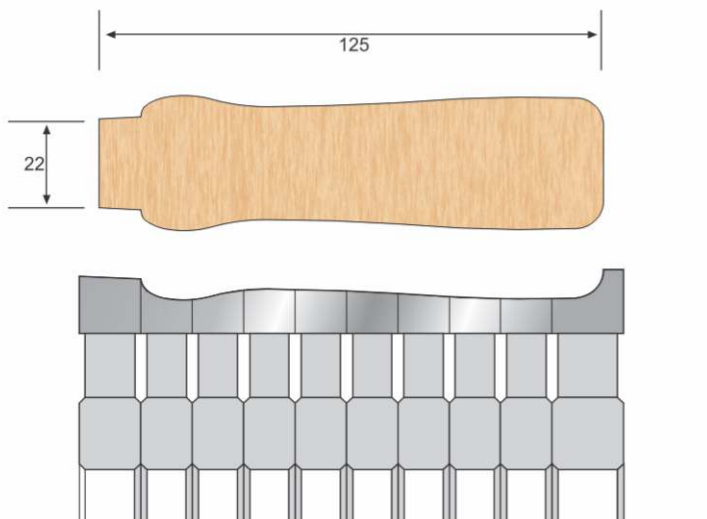

YTB 73

ORDER CODE	DIA	WOODEN LENGTH	BORE	TEETH
YTB 73 108	190	125 mm	40	8

Handel Profile Making Cutter T.C.T (Brazed) - YTB 73 (10 Pcs Set)

YTB 73

ORDER CODE	DIA	WOODEN LENGTH	BORE	TEETH
YTB 73 109	190	135 mm	40	8

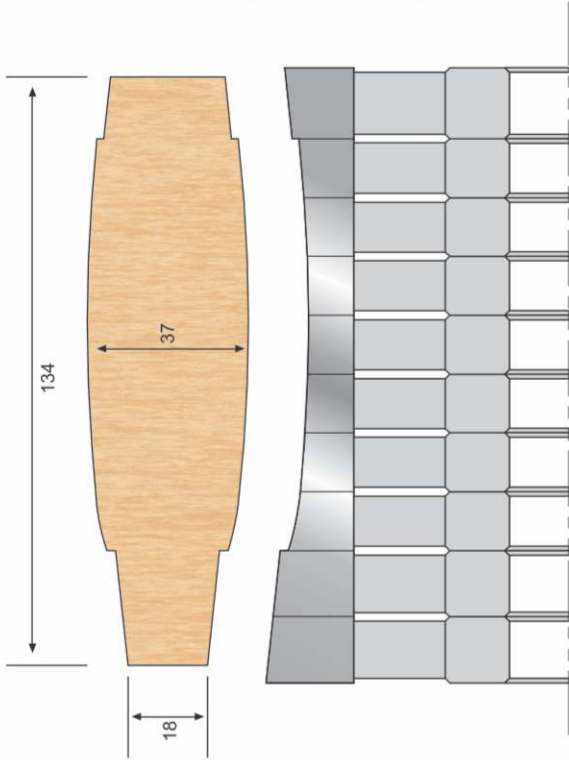

Handel Profile Making Cutter T.C.T (Brazed) - YTB 73 (53 Pcs Set)

YTB 73

ORDER CODE	DIA	WOODEN LENGTH	BORE	TEETH
YTB 73 110	190	620 mm	40	8

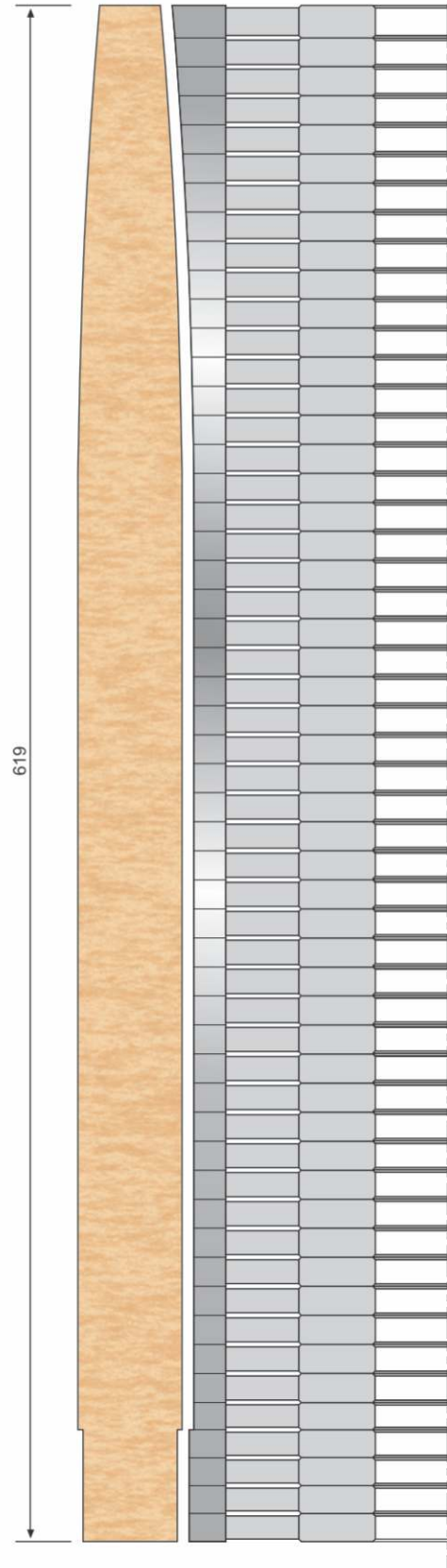

Tool For CNC Wood Turning Lathe T.C.T
(Brazed) - YTB 74

YTB 74 101



YTB 74 102

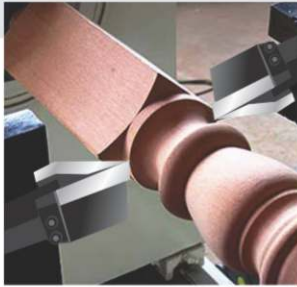

Technical Details :

Use on CNC Wood Turning Lathe

Application :

You can use these tools for a variety of woodturning tasks, such as thread cutting, grooving, finishing, and roughing. They are perfect for making turned wood components such as table legs, chair parts, and decorative spindles.

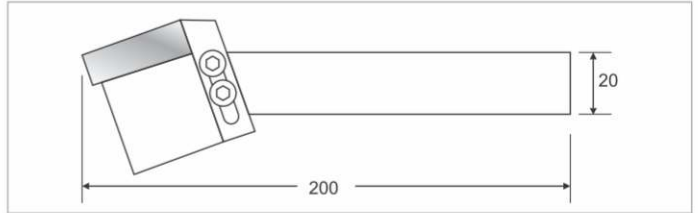

YTB 74

ORDER CODE	DISCRIPTION
YTB 74 101	Full Set - R 1
YTB 74 102	Extra Lathe Head

Tool For CNC Wood Turning Lathe T.C.T (Brazed) - YTB 74

YTB 74 103



YTB 74 104

Technical Details :

CNC Wood Turning Lathe

Application :

You can use these tools for a variety of woodturning tasks, such as thread cutting, grooving, finishing, and roughing. They are perfect for making turned wood components such as table legs, chair parts, and decorative spindles.

YTB 74

ORDER CODE	DISCRIPTION
YTB 74 103	Full Set - R 1
YTB 74 104	Extra Lathe Head

Tool For CNC Wood Turning Lathe T.C.T (Brazed) - YTB 74

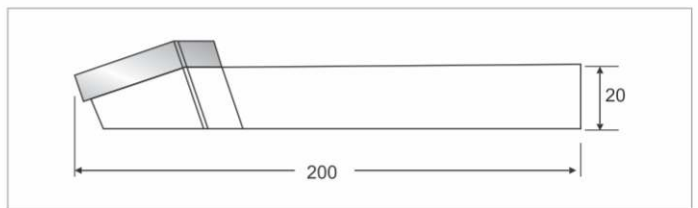

YTB 74

ORDER CODE	DESCRIPTION
YTB 74 105	Full Set - R 1 (Braze) FIX

Tool For CNC Wood Turning Lathe T.C.T (Brazed) - YTB 74



YTB 74

ORDER CODE	DESCRIPTION	SIZE
YTB 74 106	Carbide Tipped Round Road Cutter	72 x 30 x 12mm

Tenoning Cutter Head T.C.T- YTB 75



Technical Details :

Use on Tenoning Machine

Application :

Hard Wood, Soft Wood

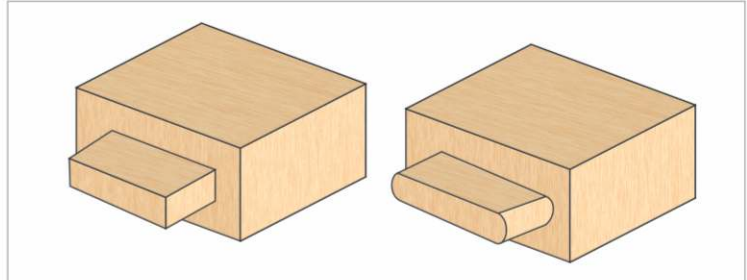

Tenoning Cutter Head T.C.T- YTB 76



Use For Motorized
YTB 161



Machine : Tenoning Machine

Application : Solid 45°, 135°, 90° Tenon Processing

Advantage : Special design for saw blade installation and replacement including 1 piece saw blade



Soft Wood



Hard Wood



Plywood



Chipboard

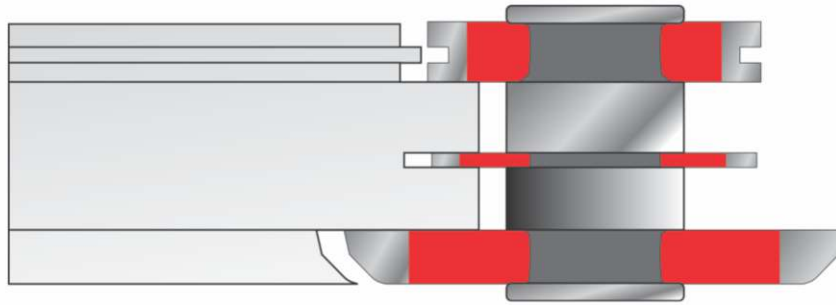
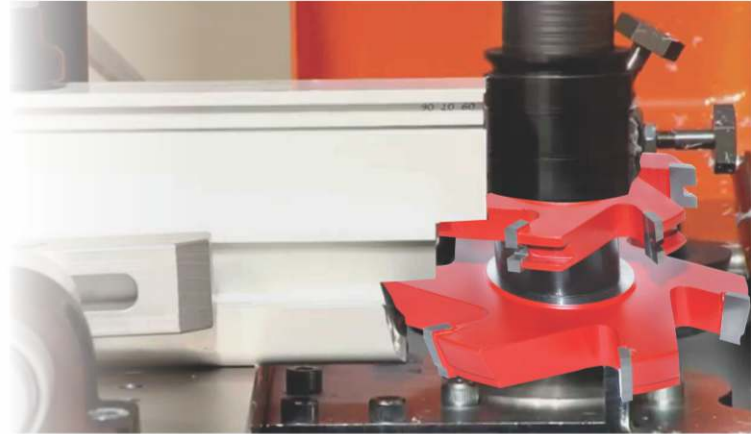

Technical Details :

upvc end milling machine

Application :

This cutter is used for perfect joining frames of windows and doors

Simta U PVC Casement Mullion **YTB 77 101**

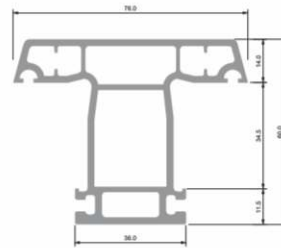

Kaka UPVC Casement Mullion **YTB 77 102**

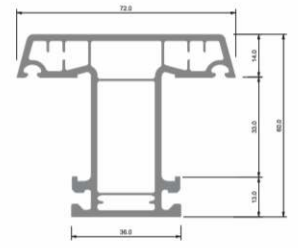

PSP UPVC Casement Mullion **YTB 77 103**

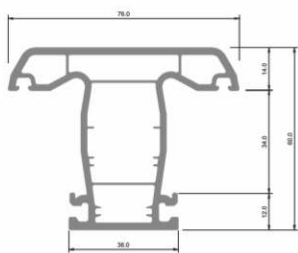

Prominance UPVC Casement Mullion **YTB 77 104**

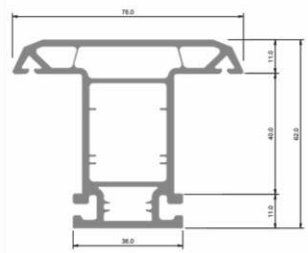

Prominance UPVC Casement Mullion **YTB 77 105**

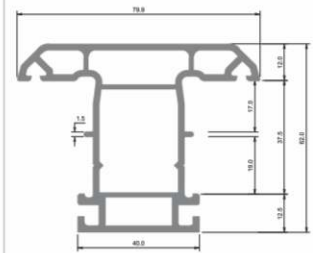

Simta UPVC Sliding & Casement Mullion **YTB 77 106**

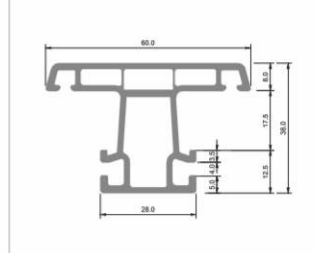

Kaka UPVC Sliding & Casement Mullion **YTB 77 107**

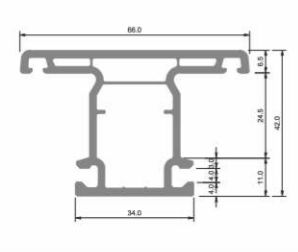

Prominance UPVC Sliding & Casement Mullion **YTB 77 108**

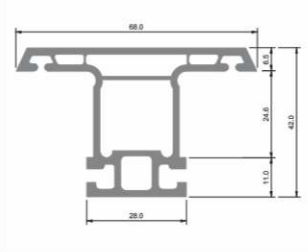

JPI UPVC Sliding & Casement Mullion **YTB 77 109**

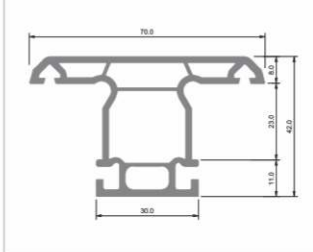

Prominance UPVC Sliding & Casement Mullion **YTB 77 110**

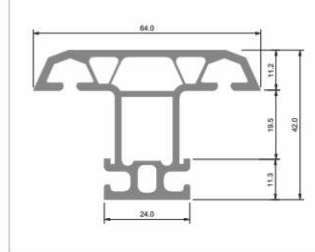

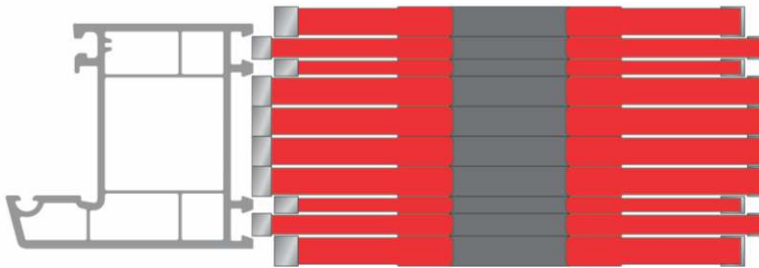
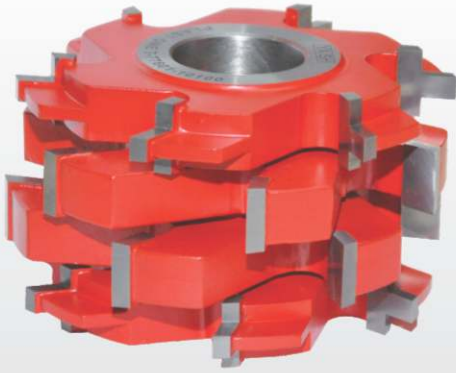

Technical Details :

upvc end milling machine

Application :

Upvc Door Window Corner Cleaning Portable Tools It is used for clean the surface welding seam of PVC/UPVC/plastic/vinyl window. door.

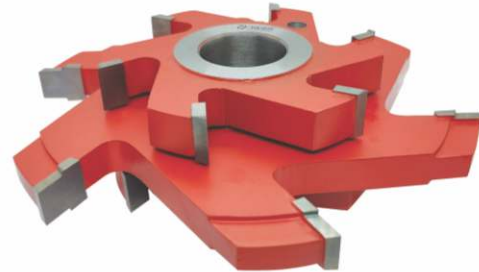

UPVC PROFILE WINDOW OUTER FRAME **YTB 78 101**

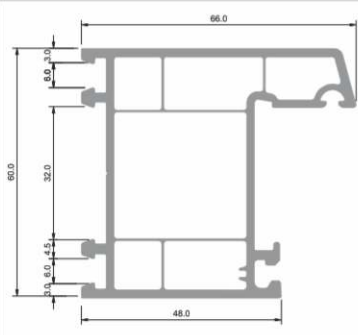

UPVC PROFILE MODIFIED/ SUPER/ SASH **YTB 78 102**

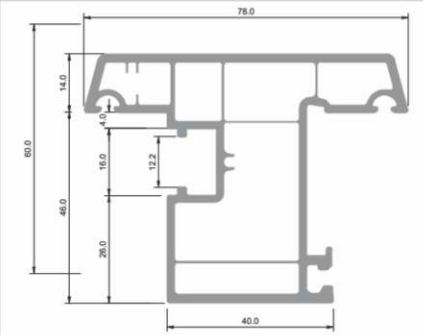

UPVC PROFILE MODIFIED/ SUPER/ SASH **YTB 78 103**

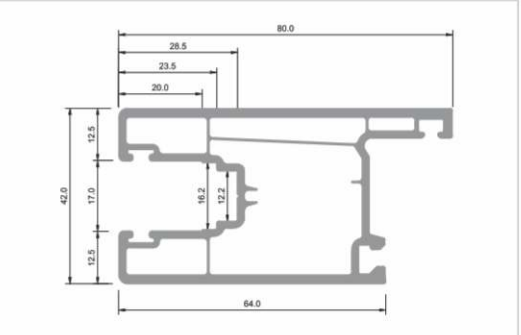

SLIDER FRAME-2 TRACK **YTB 78 104**

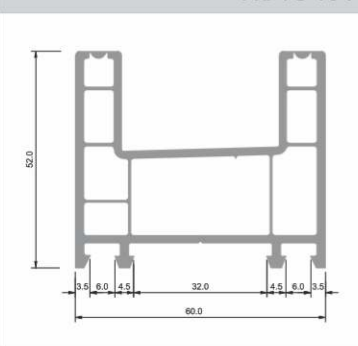

SLIDER FRAME WITH MESH TRACK **YTB 78 105**

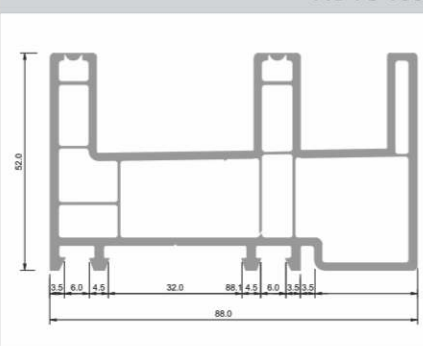

SLIDER FRAME 3- TRACK **YTB 78 106**

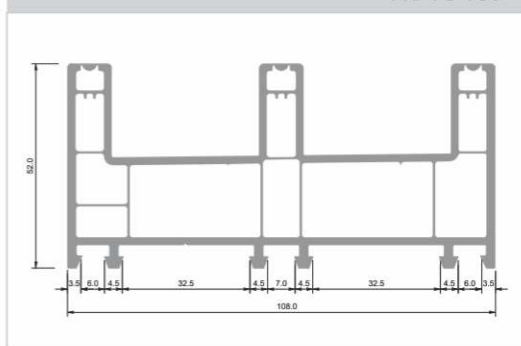

Crusher Cutter For PVC- YTB 79



YTB 79

ORDER CODE	DIA	THICK	BORE	Z	KEYWAY
YTB 79 101	259	19.5	120	12	20 X 10



Saw Blade for UPVC & Aluminum



Solid Carbide Single Flute Endmill For UPVC-

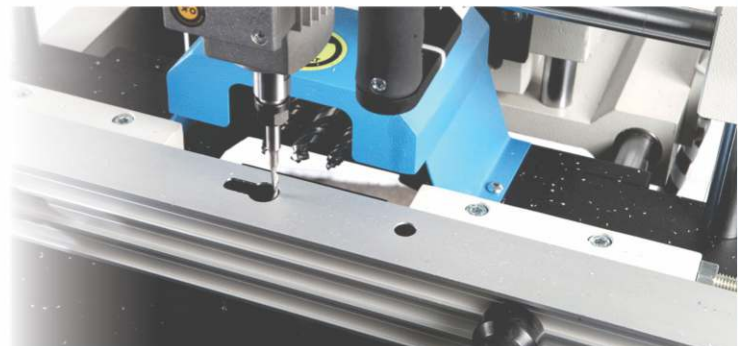

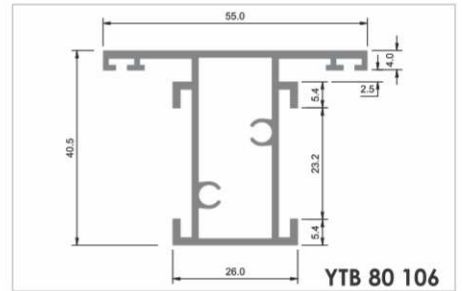
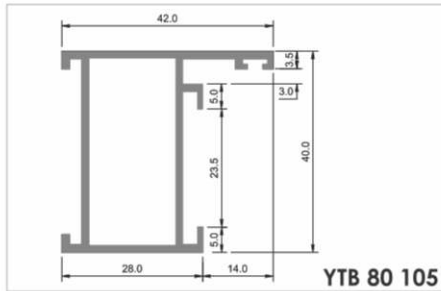
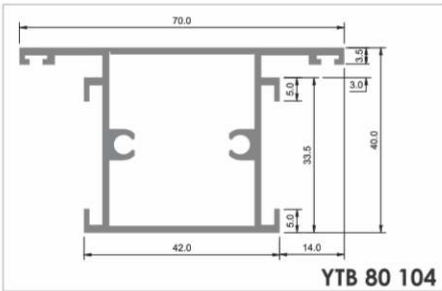
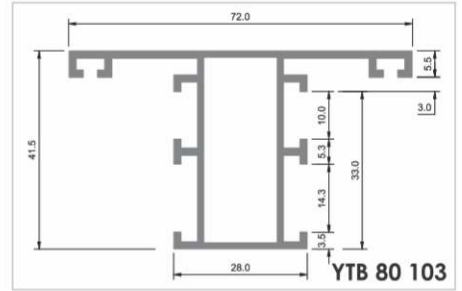
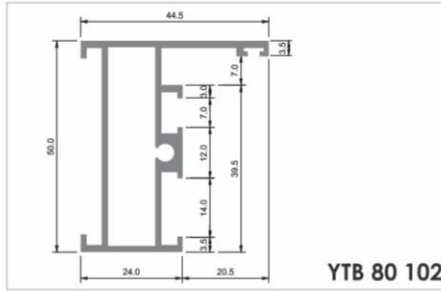
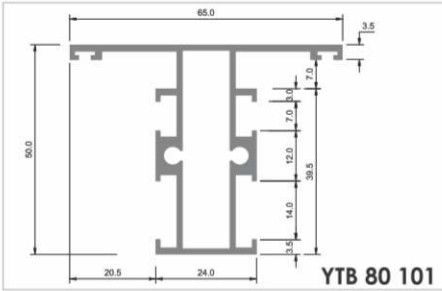
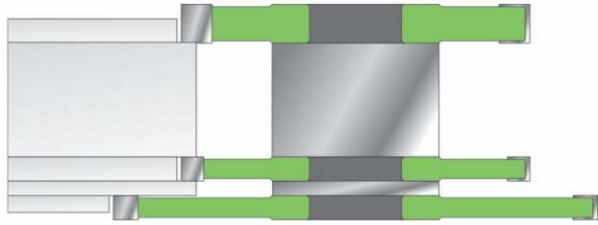
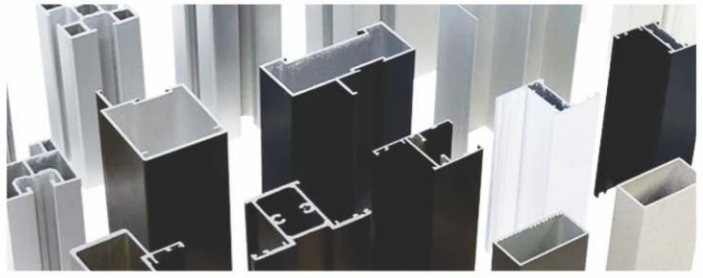

Hole Saw Bits for Aluminum Section

Solid Carbide Single Lip

Aluminum Endmill Four Flute



HSS Aluminum END MILL



New **Technology**
One **Quality**
One **Name**

Next Generation Tools By



YASH TOOLING SYSTEM

Plot No.: 462, Road No.: 12, Kathwada G. I. D. C., Odhav, Ahmedabad – 382430, Gujarat, INDIA

Phone : +91 9925430880 , 8000630880, 9925412341 **Email** : yashtoolingsystems@gmail.com